

SUGGESTED TOOLS AND MATERIALS / OUTILS ET MATÉRIAUX PROPOSÉS

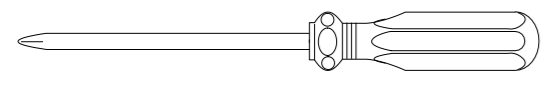

Screwdriver / Tournevis

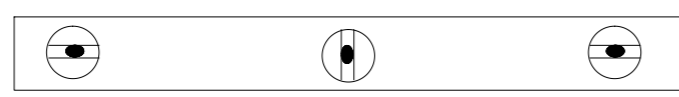

Level / Niveau

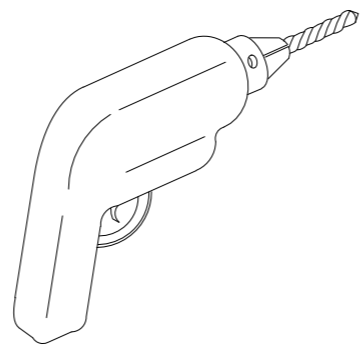

Drill / Perceuse

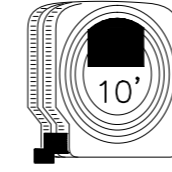

Tape Measure / Mètre à ruban

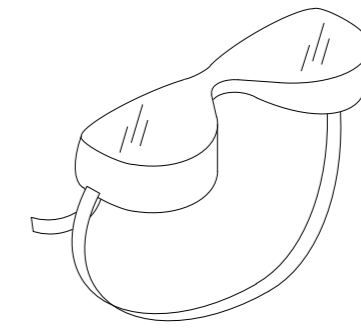

Safety Glasses / Lunettes de sécurité

PARTS / HARDWARE INCLUDED

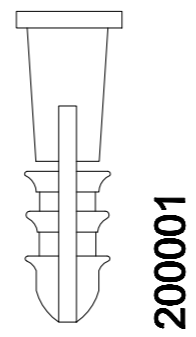

200001

4x

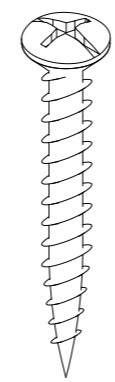

115010

4x

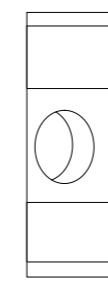

1x

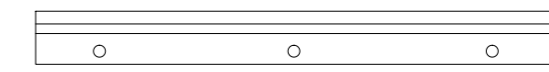

1x

INSTALLATION INSTRUCTIONS / Les instructions d'installation

1

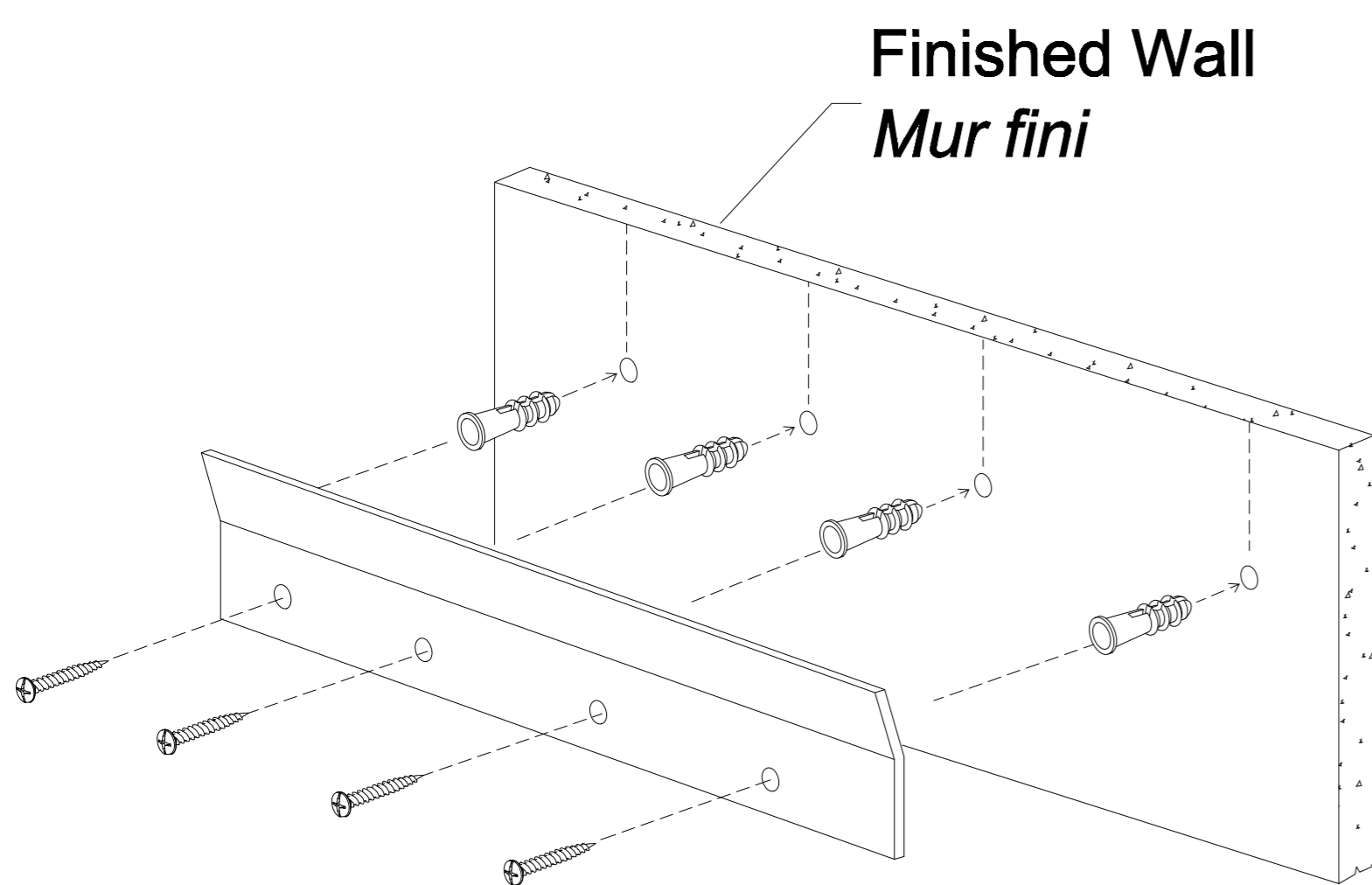

Remove metal cleat and screws from package.
Retirez le taquet métallique et les vis de l'emballage.

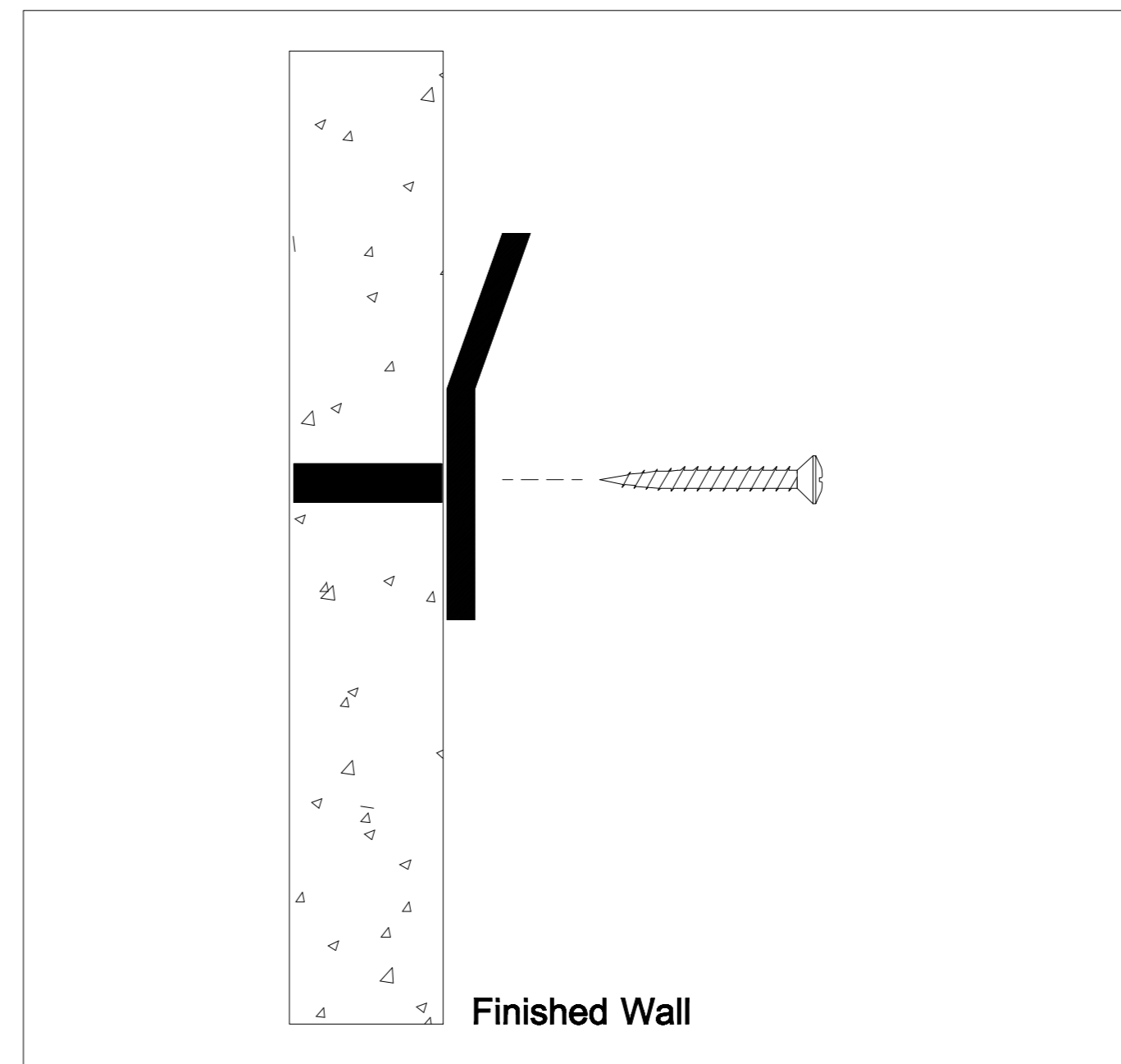

Secure the metal cleat on the finished wall with screws. Make sure to hit wall studs or use provided wall anchors.
Fixez le taquet métallique sur le mur fini avec des vis. Assurez-vous de frapper les montants du mur ou d'utiliser les chevilles fournies.

2

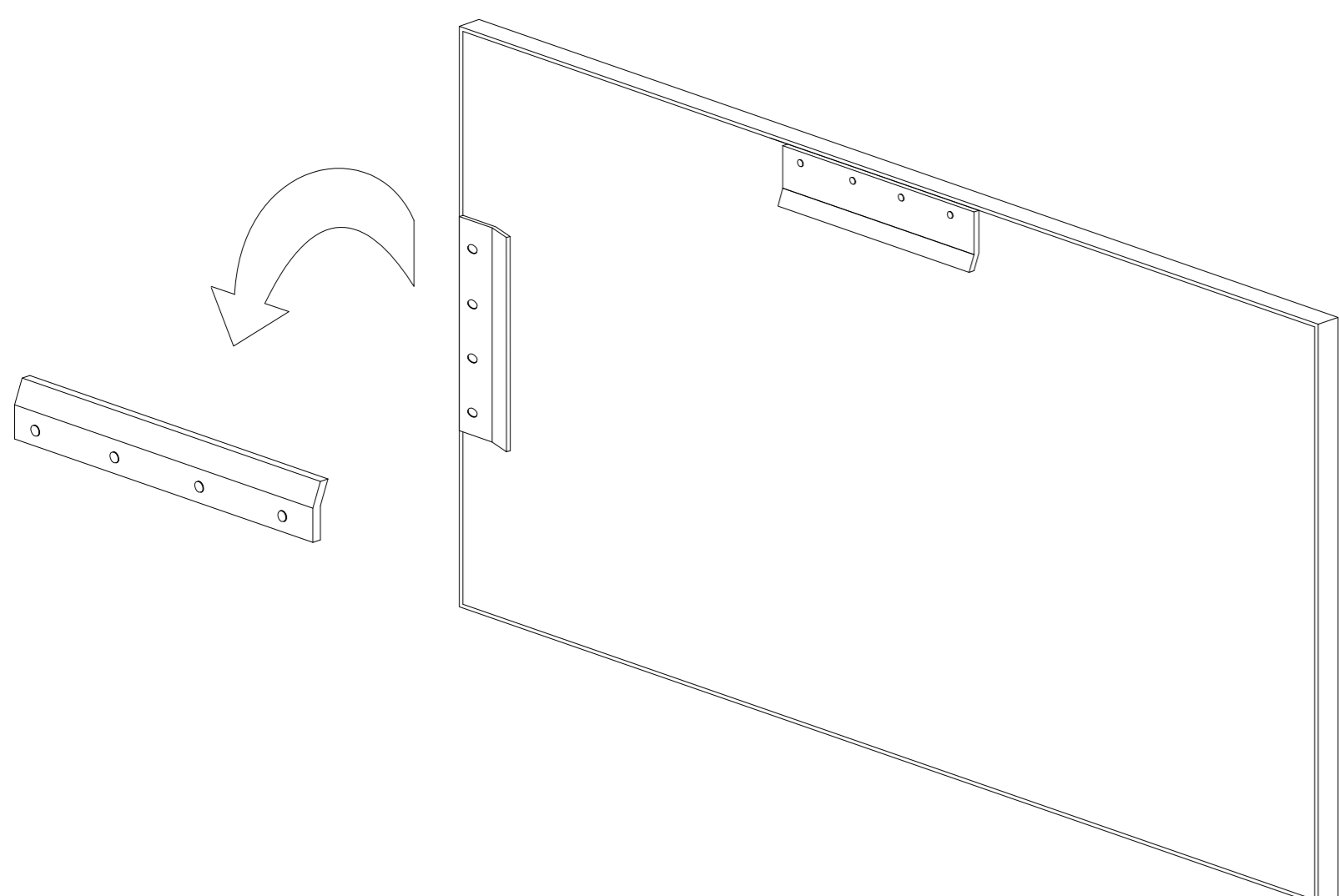

Hang mirror on the secured metal cleat.
Accrochez miroir sur sécurisé le taquet métallique.

