

79" Double Spiral Brass Hose
Model #: 3079-DS-



FEATURES:

- Double spiral brass handshower hose
- 1/2" Female threads
- Brass hex nut is on one end of the hose, and a brass conical nut to hold the handshower is on the other end
- Attach handshower to conical end of hose
- For luxury shower units

AVAILABLE FINISHES:

Polished Chrome (PCH)	Satin Chrome (SC)	Bronze Umber (BU)
Satin Nickel (SN)	Pewter (PEW)	Caramel Bronze (CB)
Polished Nickel (PN)	Antique Brass (AB)	Antique Copper (ACU)
Oil-Rubbed Bronze (ORB)	Polished Brass (PB)	Polished Copper (PCU)
Vintage Bronze (VB)	Satin Brass (SB)	Rose Gold (RG)
Matte Black (MBK)	Satin Gold (SG)	Polished Gold (PG)
Black Nickel (BKN)	Bombay Gold (BG)	Jewelers Gold (JG)
Europa Bronze (EB)	Tristan Brass (TB)	Unlacquered Brass (ULB)
Satin Cooper (SCU)		

SPECIFICATION DRAWING:

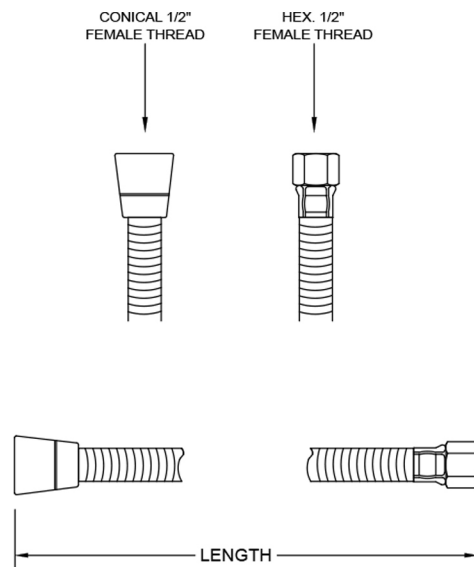

DOUBLE SPIRAL BRASS HOSE		
PART #	DESCRIPTION	LENGTH
3024-DS	DOUBLE SPIRAL BRASS HOSE 24"	24"
3049-DS	DOUBLE SPIRAL BRASS HOSE 49"	49"
3060-DS	DOUBLE SPIRAL BRASS HOSE 60"	60"
3071-DS	DOUBLE SPIRAL BRASS HOSE 71"	71"
3079-DS	DOUBLE SPIRAL BRASS HOSE 79"	79"