

23 5/8"

Item Number:
E213-V24-WLT
E213-V24-GW
E213-V24-WWW
E213-V24-NVB

JAMES MARTIN

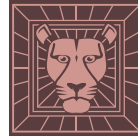

VANITIES™

Linden 23 5/8" Cabinet
Diagrams with Dimensions
page 01 of 03

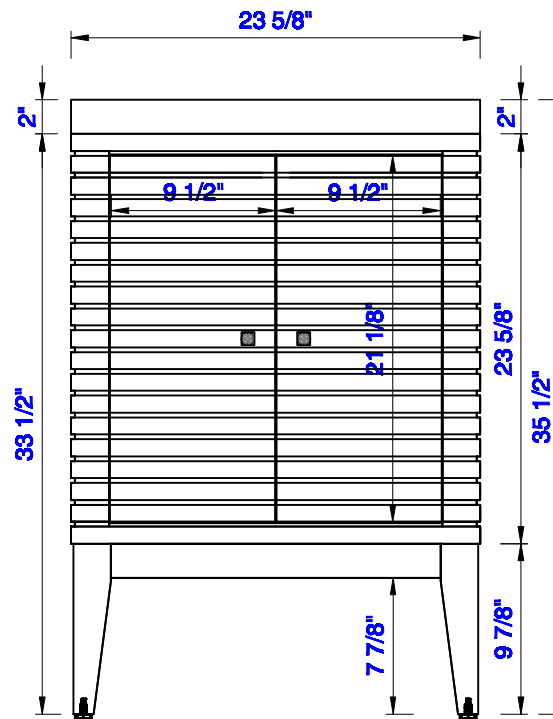

NOTE ONE: Countertop with integrated sink is shown on this cabinet
NOTE TWO: This vanity does not have a Backsplash.

Version:202004

23 5/8"

Item Number:
E213-V24-WLT
E213-V24-GW
E213-V24-WWW
E213-V24-NVB

JAMES MARTIN

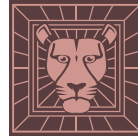

VANITIES™

Linden 23 5/8" Cabinet
Diagrams with Dimensions
page 02 of 03

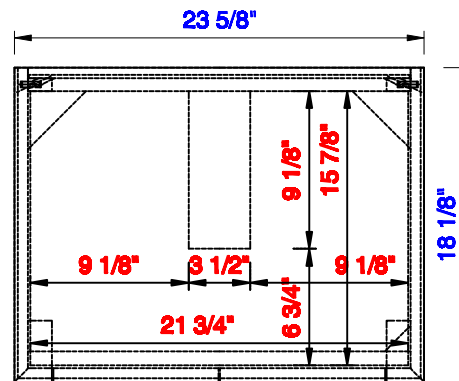
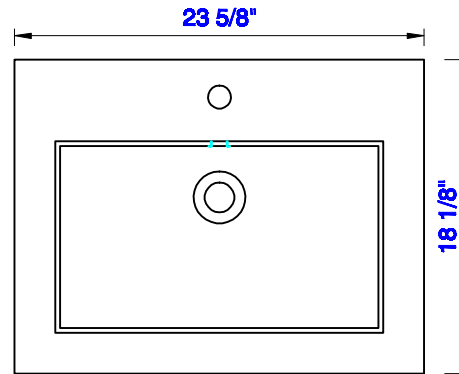

NOTE ONE: Countertop with integrated sink is shown on this cabinet.

Version:202004

23 5/8"

Item Number:
E213-V24-WLT
E213-V24-GW
E213-V24-WWW
E213-V24-NVB

JAMES MARTIN

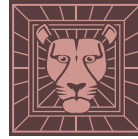

VANITIES™

Linden 23 5/8" Cabinet
Diagrams with Dimensions
page 03 of 03

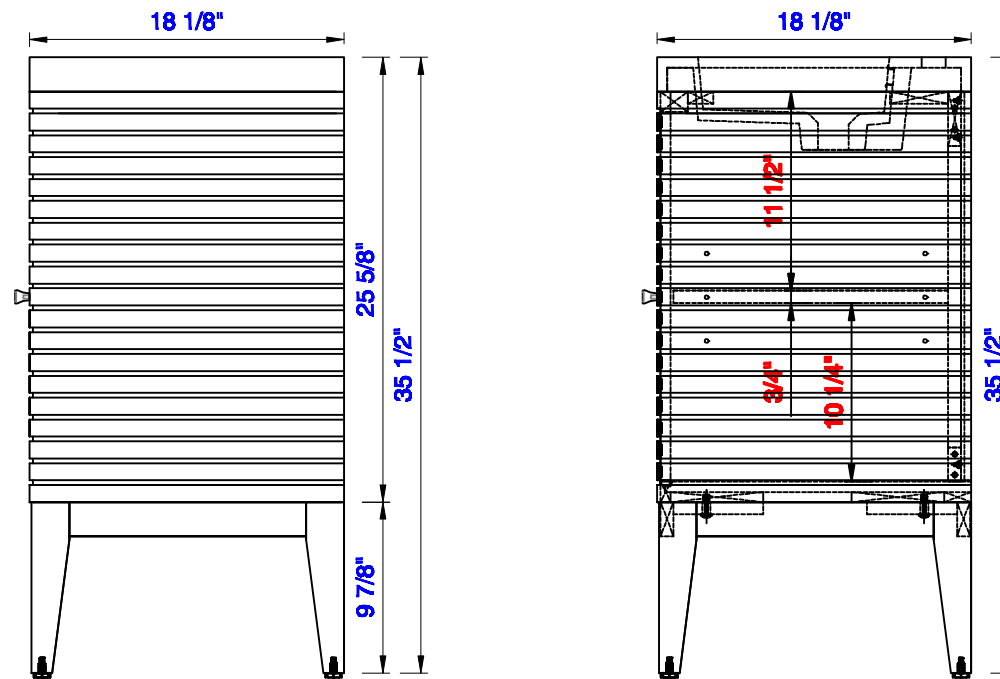

NOTE ONE: Countertop with integrated sink is shown on this cabinet
NOTE TWO: This vanity does not have a Backsplash.

Version:202004

600mm

Item Number:
E213-V24-WLT
E213-V24-GW
E213-V24-WWW
E213-V24-NVB

JAMES MARTIN

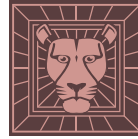

VANITIES™

Linden 600mm Cabinet
Diagrams with Dimensions
page 01 of 03

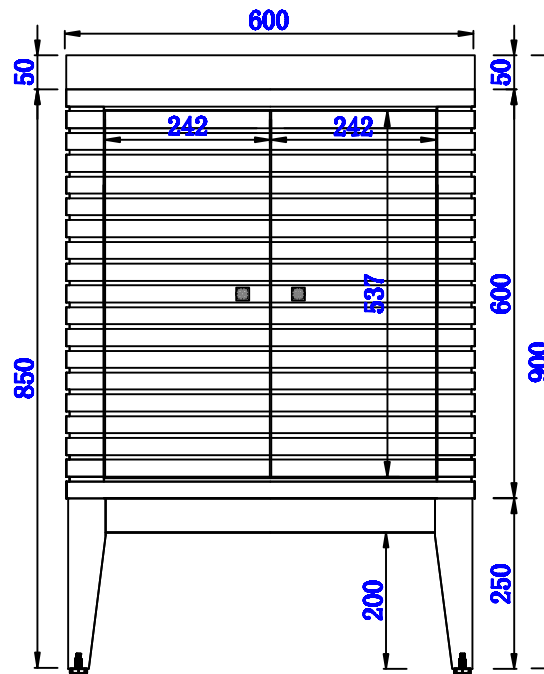

NOTE ONE: Countertop with integrated sink is shown on this cabinet
NOTE TWO: This vanity does not have a Backsplash.

Version:202004

600mm

Item Number:
E213-V24-WLT
E213-V24-GW
E213-V24-WWW
E213-V24-NVB

JAMES MARTIN

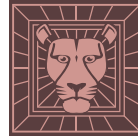

VANITIES™

Linden 600mm Cabinet
Diagrams with Dimensions
page 02 of 03

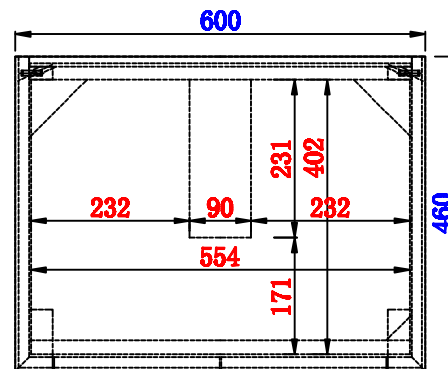
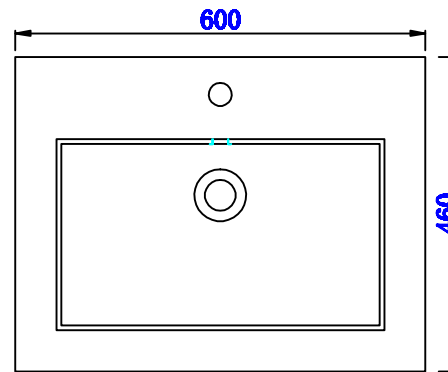

NOTE ONE: Countertop with integrated sink is shown on this cabinet.

Version:202004

600mm

Item Number:
E213-V24-WLT
E213-V24-GW
E213-V24-WWW
E213-V24-NVB

JAMES MARTIN

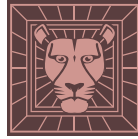

VANITIES™

Linden 600mm Cabinet
Diagrams with Dimensions
page 03 of 03

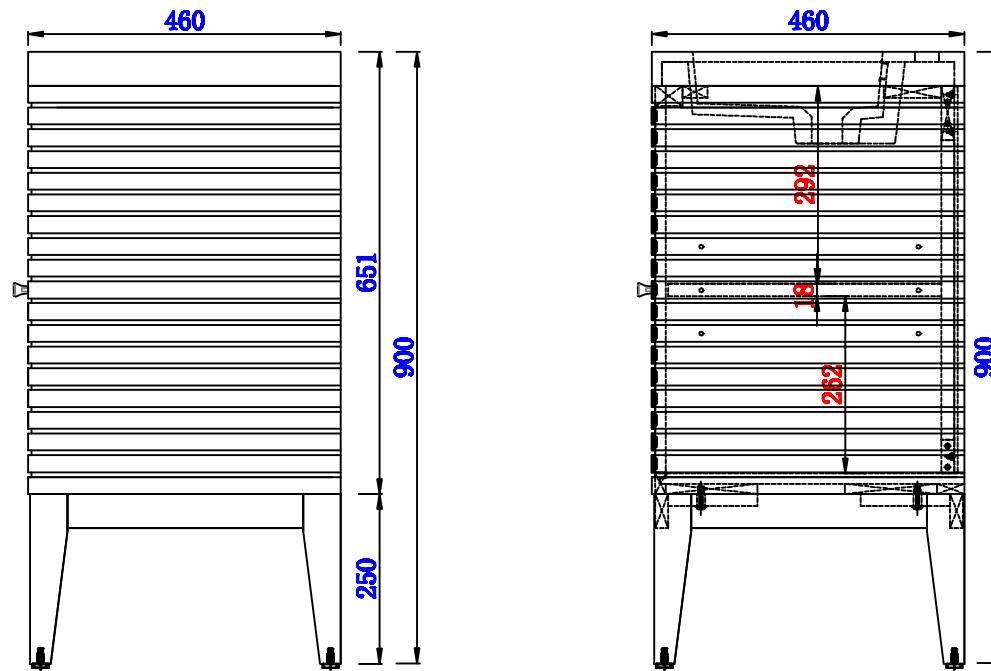

NOTE ONE: Countertop with integrated sink is shown on this cabinet
NOTE TWO: This vanity does not have a Backsplash.