

46"

Item Number:

- 650-V46-BKO
- 650-V46-BNM
- 650-V46-CWH
- 650-V46-UGR
- 650-V46-VBL

JAMES MARTIN

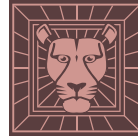

VANITIES™

Brittany 46" Single Vanity

Diagrams with Dimensions
page 01 of 03

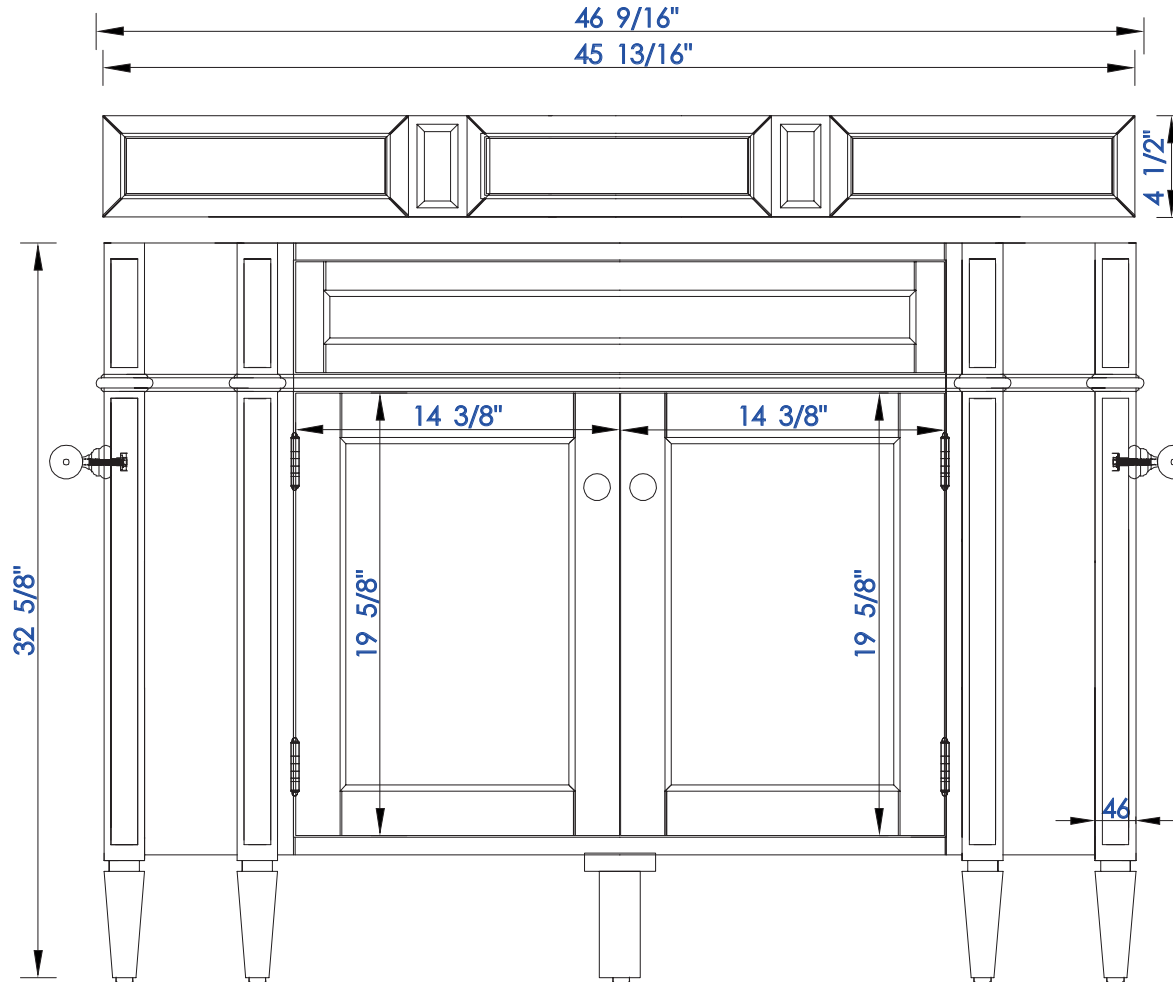

NOTE ONE: Countertops are not shown in these diagrams. (Cabinet Only)

NOTE TWO: Wood Backsplash (Shown) is designed for the molding detail to align with sinks in James Martin's Optional Countertops. Customer's own countertops and sinks may align differently.

Please consult our website for Countertop Diagrams: www.jamesmartinvanities.com

Version: 201906

46"

Item Number:

- 650-V46-BKO
- 650-V46-BNM
- 650-V46-CWH
- 650-V46-UGR
- 650-V46-VBL

JAMES MARTIN



VANITIES™

Brittany 46" Single Vanity

Diagrams with Dimensions
page 02 of 03

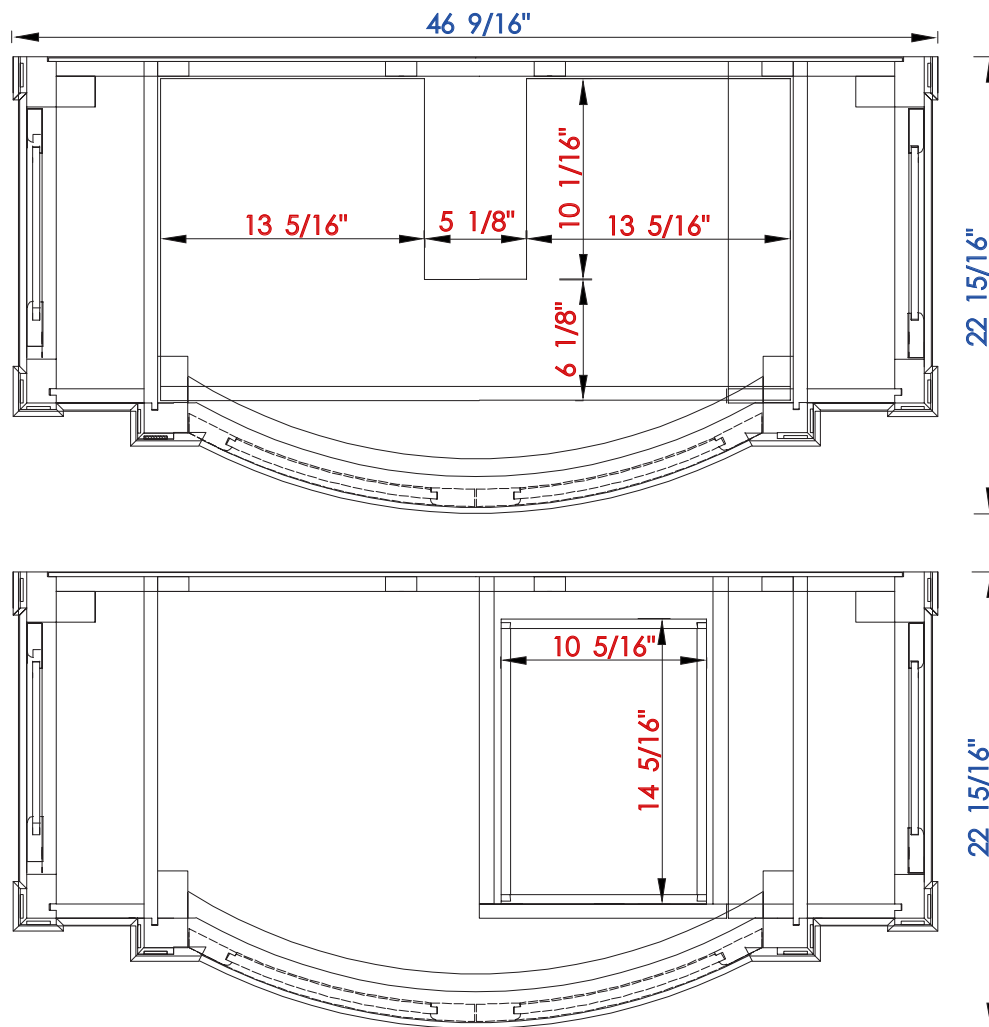

NOTE ONE: Countertops are not shown in these diagrams. (Cabinet Only)

NOTE TWO: Internal Shelves(Shown) are designed to align with sinks in James Martin's Optional Countertops. Customer's own countertops and sink may align differently, and modification may be required. Please consult our website for Countertop Diagrams: www.jamesmartinvanities.com

46"

Item Number:

- 650-V46-BKO
- 650-V46-BNM
- 650-V46-CWH
- 650-V46-UGR
- 650-V46-VBL

JAMES MARTIN

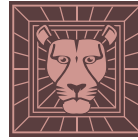

VANITIES™

Brittany 46" Single Vanity

Diagrams with Dimensions
page 03 of 03

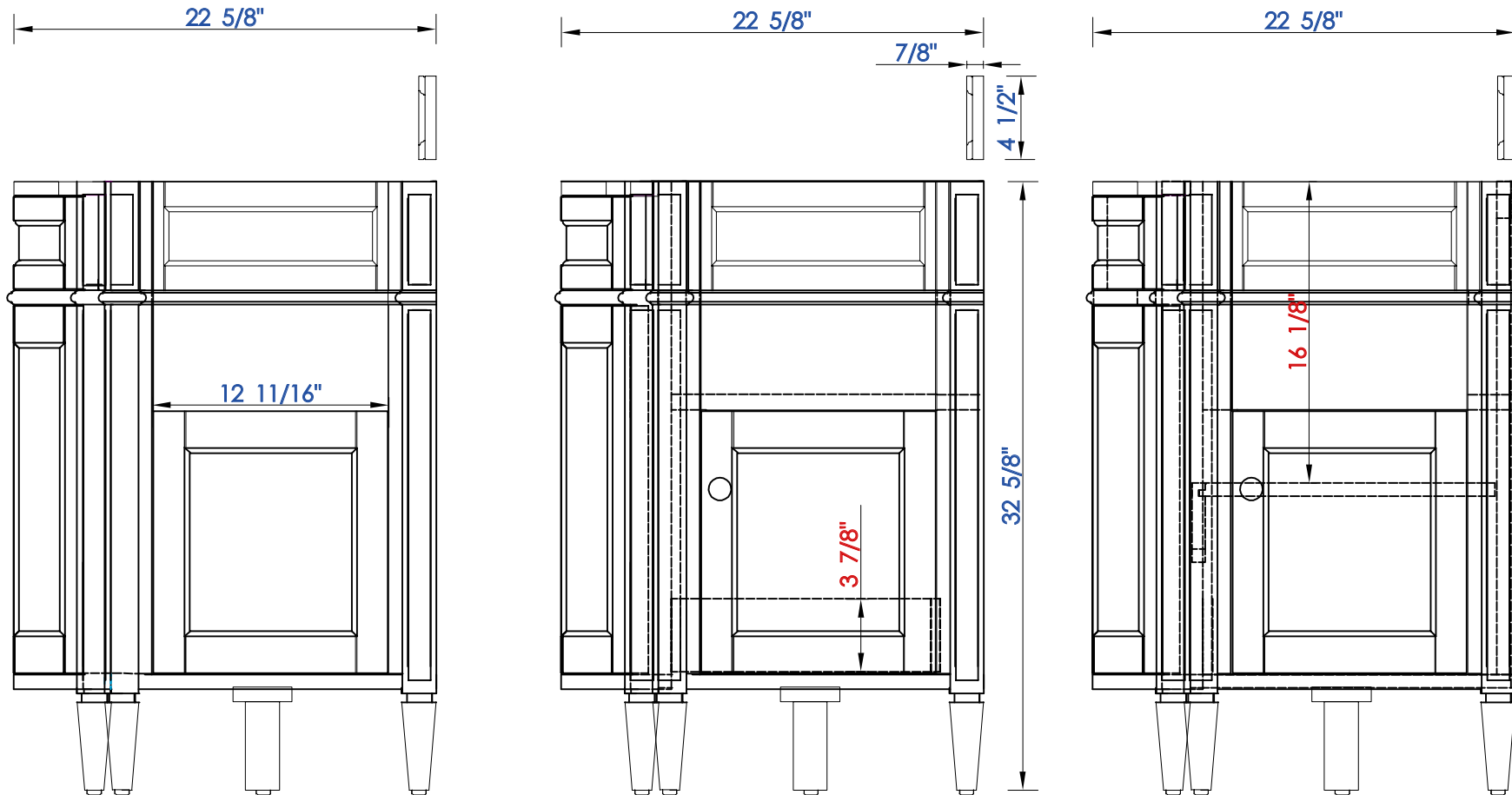

NOTE ONE: Countertops are not shown in these diagrams. (Cabinet Only)

NOTE TWO: Wood Backsplash (Shown) is designed for the molding detail to align with sinks in James Martin's Optional Countertops.
Customer's own countertops and sinks may align differently.

Please consult our website for Countertop Diagrams: www.jamesmartinvanities.com

Version: 201906

1168 mm

Item Number:

- 650-V46-BKO
- 650-V46-BNM
- 650-V46-CWH
- 650-V46-UGR
- 650-V46-VBL

JAMES MARTIN

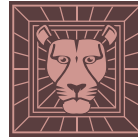

VANITIES™

Brittany 1168 mm Single Vanity

Diagrams with Dimensions
page 01 of 03

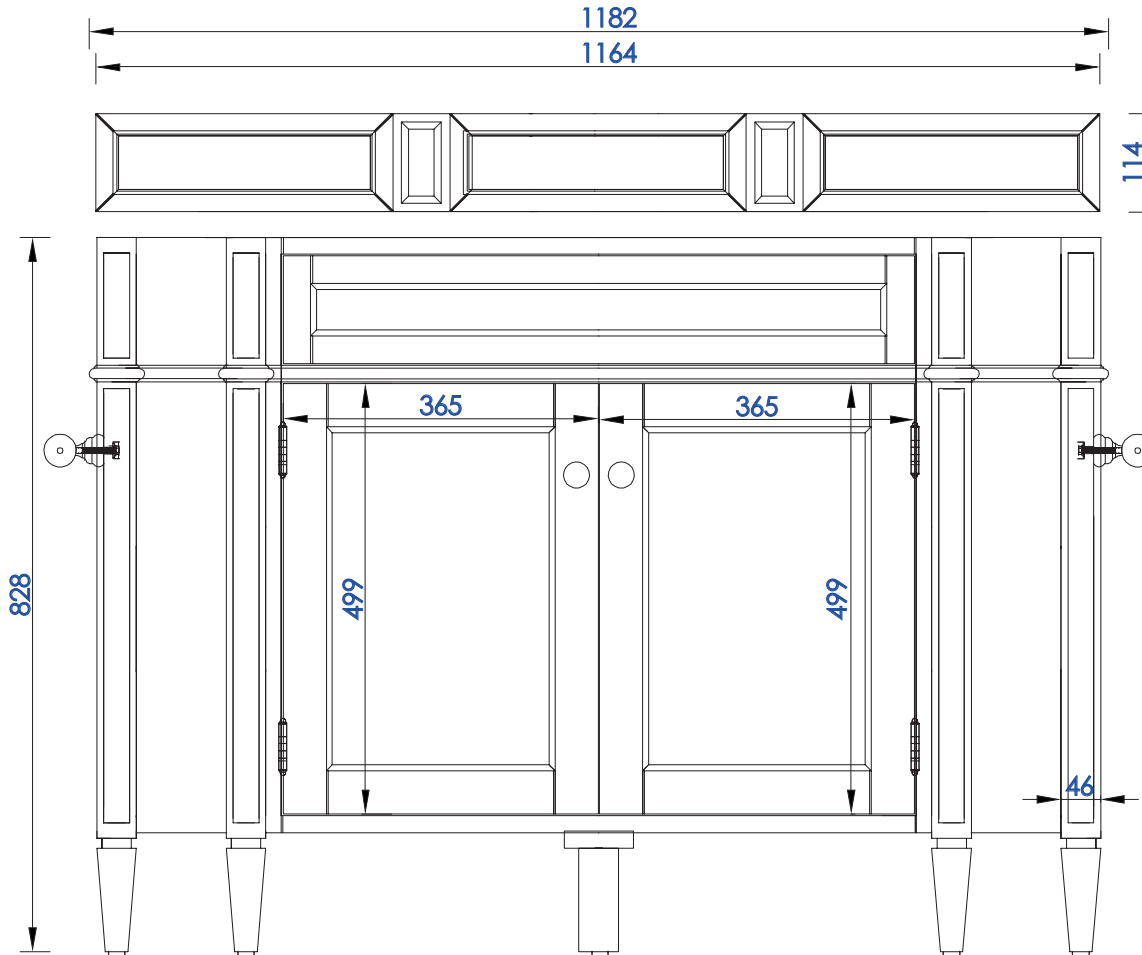

NOTE ONE: Countertops are not shown in these diagrams. (Cabinet Only)

NOTE TWO: Wood Backsplash (Shown) is designed for the molding detail to align with sinks in James Martin's Optional Countertops. Customer's own countertops and sinks may align differently, and modification may be required.

Please consult our website for Countertop Diagrams: www.jamesmartinvanities.com

1168 mm

Item Number:

- 650-V46-BKO
- 650-V46-BNM
- 650-V46-CWH
- 650-V46-UGR
- 650-V46-VBL

JAMES MARTIN

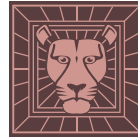

VANITIES™

Brittany 1168 mm Single Vanity

Diagrams with Dimensions
page 02 of 03

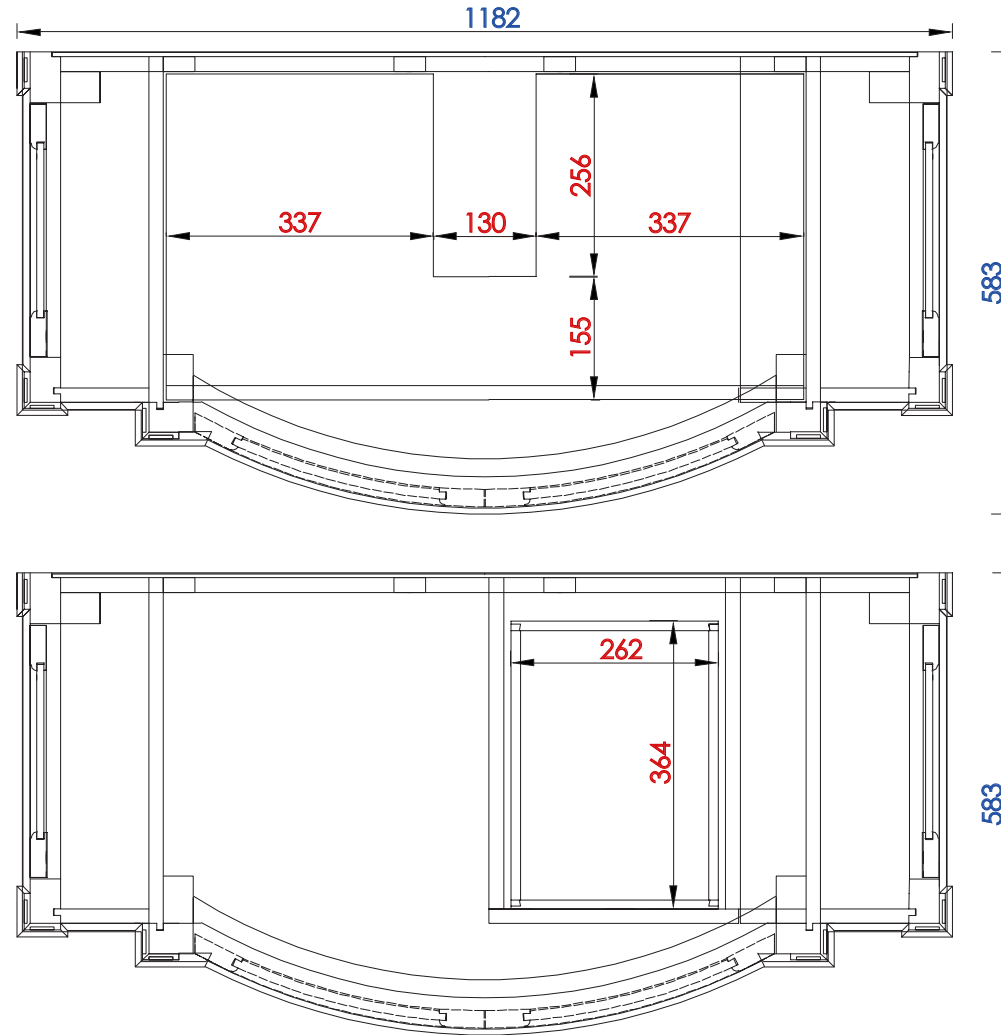

NOTE ONE: Countertops are not shown in these diagrams. (Cabinet Only)

NOTE TWO: Internal Shelves(Shown) are designed to align with sinks in James Martin's Optional Countertops. Customer's own countertops and sink may align differently, and modification may be required. Please consult our website for Countertop Diagrams: www.jamesmartinvanities.com

1168 mm

Item Number:

- 650-V46-BKO
- 650-V46-BNM
- 650-V46-CWH
- 650-V46-UGR
- 650-V46-VBL

JAMES MARTIN



VANITIES™

Brittany 1168 mm Single Vanity

Diagrams with Dimensions
page 03 of 03

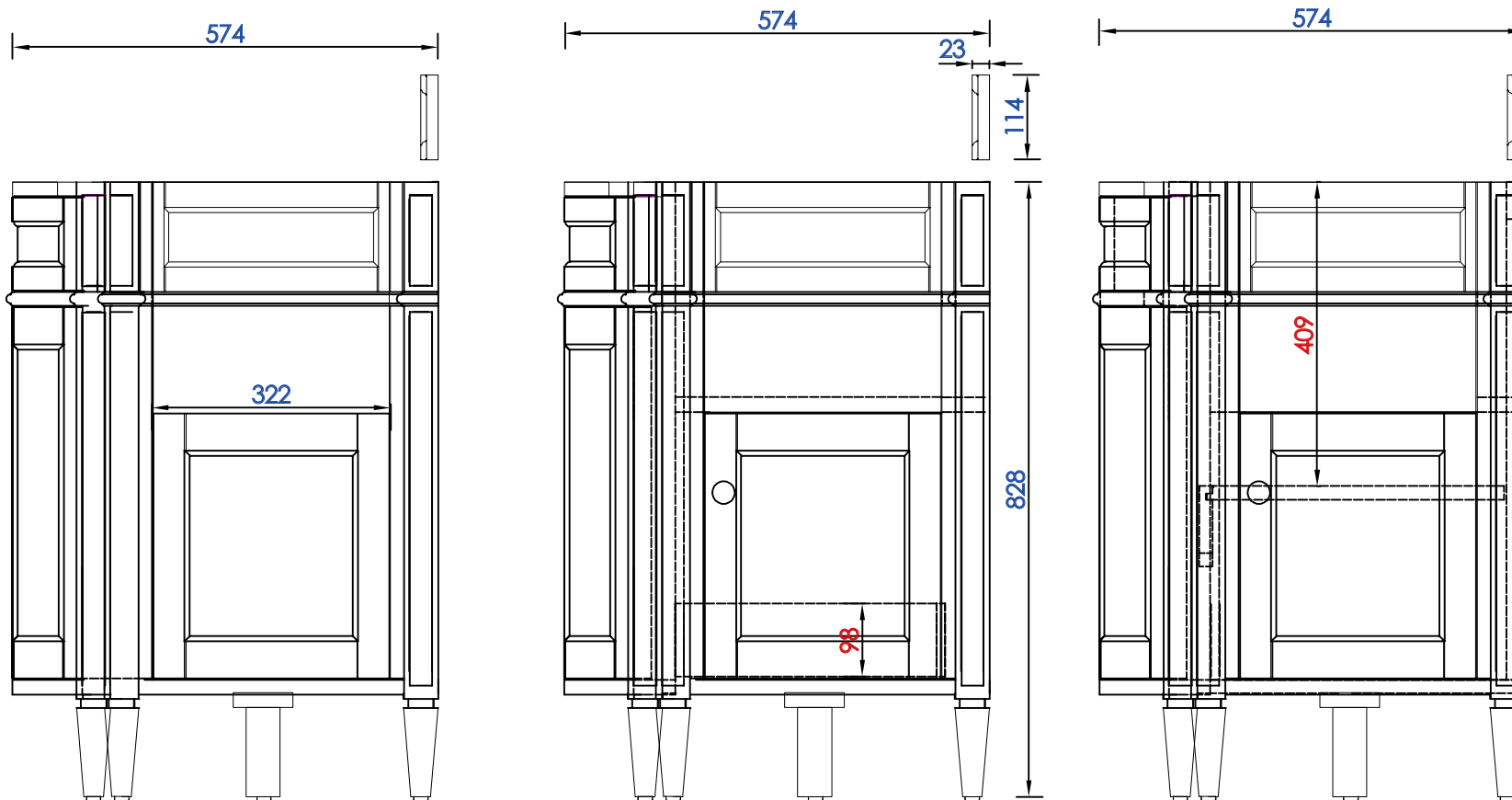

NOTE ONE: Countertops are not shown in these diagrams. (Cabinet Only)

NOTE TWO: Wood Backsplash (Shown) is designed for the molding detail to align with sinks in James Martin's Optional Countertops.

Customer's own countertops and sinks may align differently, and modification may be required.

Please consult our website for Countertop Diagrams: www.jamesmartinvanities.com