



# DOLCE AD660D

Countertop: QT60D / Sink: AD66CS

| Dimensions: | width   | depth  | height  |
|-------------|---------|--------|---------|
| inches      | 59.125" | 19.75" | 34.875" |
| mm          | 1502    | 502    | 886     |

NOTE: DIMENSIONS AND TECHNICAL DETAILS ARE SUBJECT TO CHANGE WITHOUT NOTICE

. FRONT ELEVATION

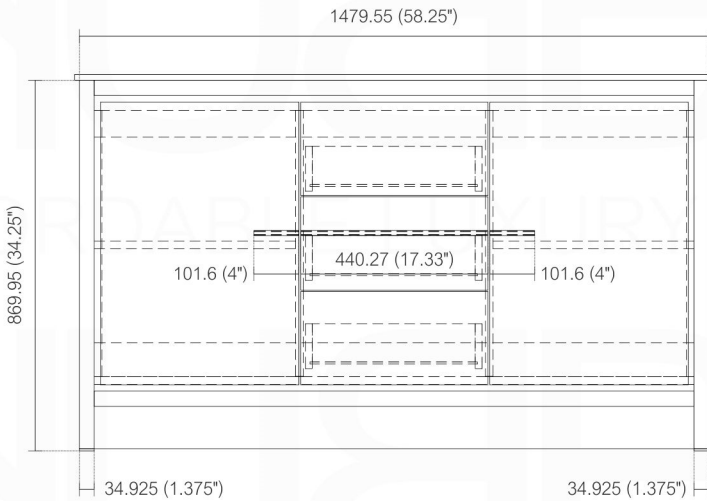

. SIDE ELEVATION

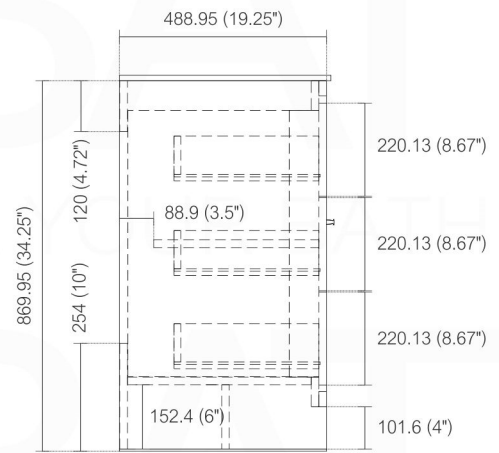

. TOP ELEVATION

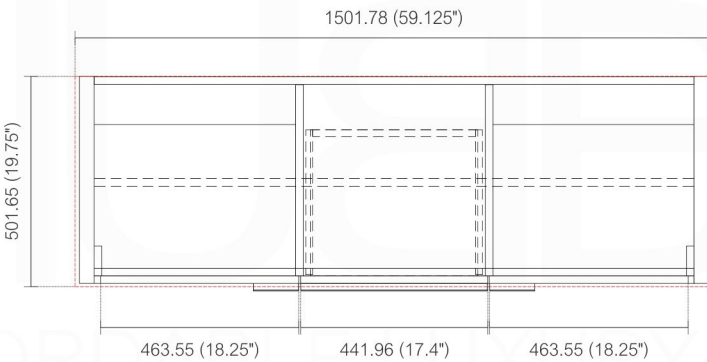

NOTE: DIMENSIONS AND TECHNICAL DETAILS ARE SUBJECT TO CHANGE WITHOUT NOTICE

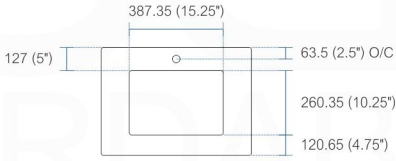

product code  
QT24

| Dimensions: | width  | depht  | height |
|-------------|--------|--------|--------|
| inches      | 23.75" | 19.75" | 0.625" |
| mm          | 603.25 | 501.65 | 15.875 |

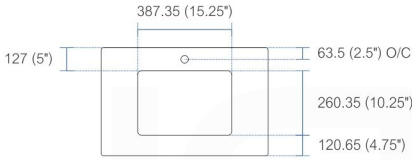

product code  
QT30

| Dimensions: | width   | depht  | height |
|-------------|---------|--------|--------|
| inches      | 29.125" | 19.75" | 0.625" |
| mm          | 739.775 | 501.65 | 15.875 |

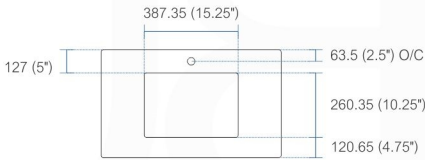

product code  
QT36 | QT36L | QT36R

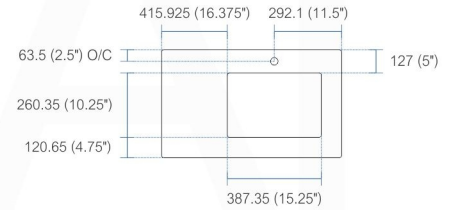
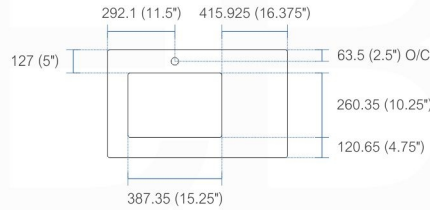

| Dimensions: | width | depht  | height |
|-------------|-------|--------|--------|
| inches      | 35.5" | 19.75" | 0.625" |
| mm          | 901.7 | 501.65 | 15.875 |

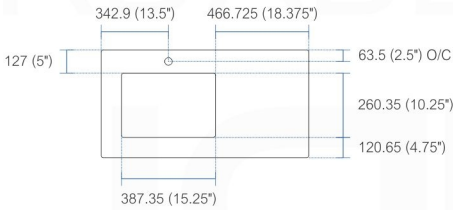

product code  
QT40

| Dimensions: | width  | depht  | height |
|-------------|--------|--------|--------|
| inches      | 39.5"  | 19.75" | 0.625" |
| mm          | 1003.3 | 501.65 | 15.875 |

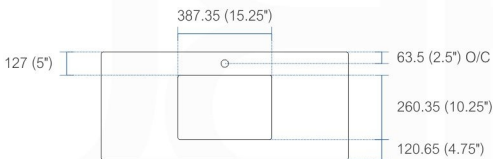

product code  
QT48S

| Dimensions: | width   | depht  | height |
|-------------|---------|--------|--------|
| inches      | 47.25"  | 19.75" | 0.625" |
| mm          | 1200.15 | 501.65 | 15.875 |

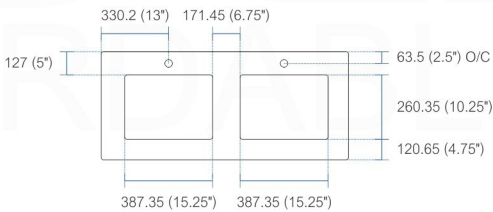

product code  
QT48D

| Dimensions: | width   | depht  | height |
|-------------|---------|--------|--------|
| inches      | 47.25"  | 19.75" | 0.625" |
| mm          | 1200.25 | 501.65 | 15.875 |

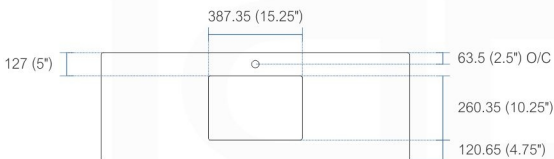

product code  
QT60S

| Dimensions: | width   | depht  | height |
|-------------|---------|--------|--------|
| inches      | 59.125" | 19.75" | 0.625" |
| mm          | 1501.78 | 501.65 | 15.875 |

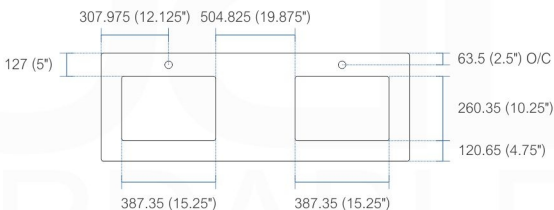

product code  
QT60D

| Dimensions: | width   | depht  | height |
|-------------|---------|--------|--------|
| inches      | 59.125" | 19.75" | 0.625" |
| mm          | 1501.78 | 501.65 | 15.875 |

# CERAMIC UNDERMOUNT SINK AD66CS

Counter cutout opening: 387.35 (15.25") W x 260.35 (10.25") D

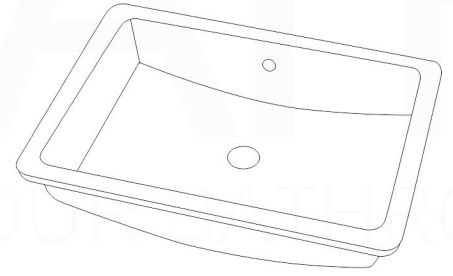

TOP ELEVATION

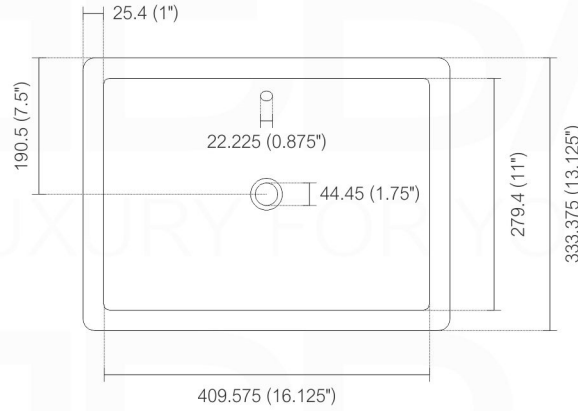

FRONT ELEVATION

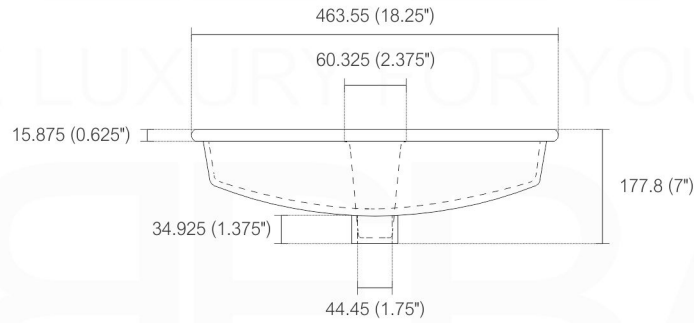

SIDE ELEVATION

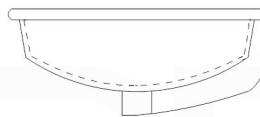

## CERAMIC UNDERMOUNT SINK - INSTALLATION

1. Unpack the new sink and check the contents of the materials supplied.
2. Clean the underside of the countertop and the rim of the sink.
3. Use actual basin as your template. Place it upside down on countertop by tracing edge of basin. Be sure to allow clearance for faucet and other accessories or fixtures.
4. Generously apply 100% silicone sealant around the rim.
5. Position the sink under the opening and install the clamps.
  - \* Use level to make sure that the basin is sitting level in all directions , front to back and side to side, while pressing down to seal. Carefully remove any excess silicone.
  - \* Leave to cure for 24 hours before removing the clamps.

**Note:** Sink style, shape, cutout on top may vary from the picture above. Instructional purposes only.

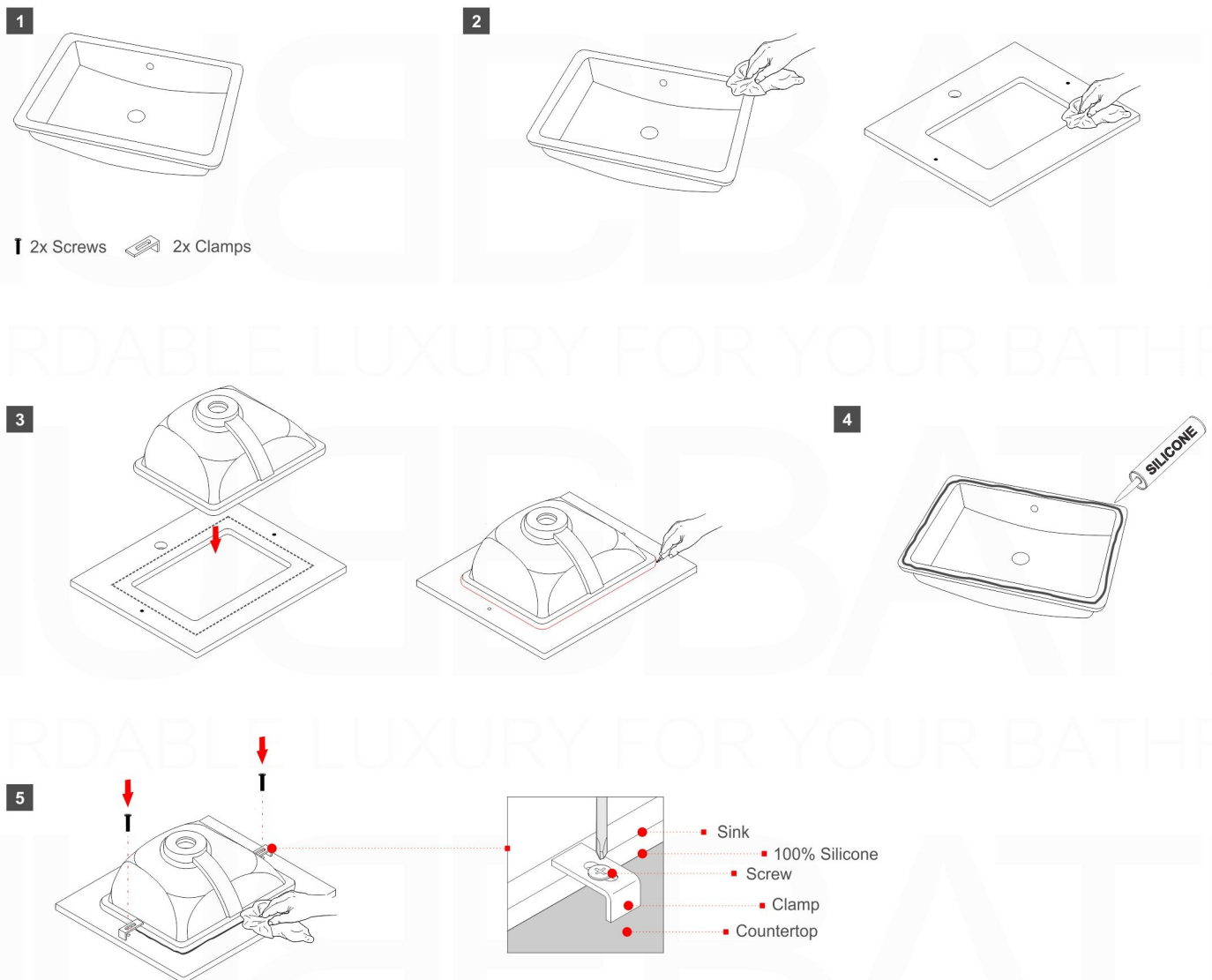

## How to Install a Dolce Vanity | Remove / Install Drawers | Adjust Doors

### INSTALLATION GUIDE

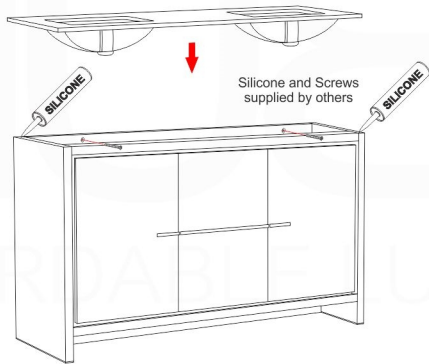

1. Determine your vanity placement and mark the area on the wall where it will be installed.
2. Locate and mark the location of the studs to which you will fasten your vanity. You can find studs by listening for a solid sound as you knock on the wall or by using a stud finder.
3. If your vanity cabinet has a solid back, mark and drill holes to accommodate drain pipes and supply pipes as necessary.
4. Place the vanity in the installation location. Verify that the vanity cabinet is level. If the vanity is not level, use vanity feet (if included) or wooden shims to adjust as necessary.
5. Attach the vanity to the wall by screwing through the mounting rail in the back of the vanity cabinet into the wall studs.
6. Install the integral sink/vanity top by applying a dot of silicone sealant on the corners of the vanity. Position the vanity top onto the vanity and press firmly into place. Wipe away any excess sealant with a damp cloth.

**Note:** We recommend consulting professional help if you are unfamiliar with installing bathroom vanities and/or plumbing.

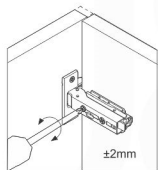

Side adjustment

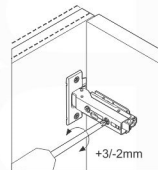

Depth adjustment via worm gear

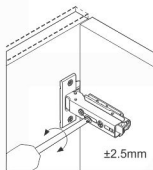

Depth adjustment via worm gear

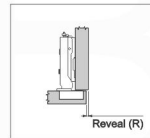

Full Overlay/ Overlay Door

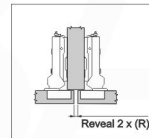

Half Overlay Door

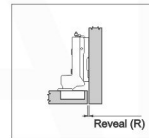

Inset Door

### REMOVE DRAWERS

(Locate the screws on the bottom of the drawer)

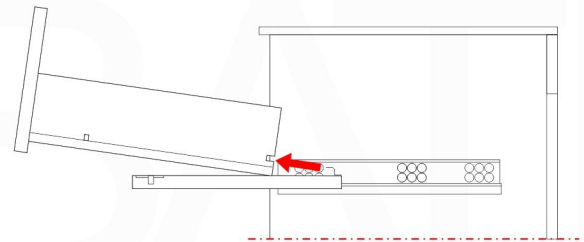
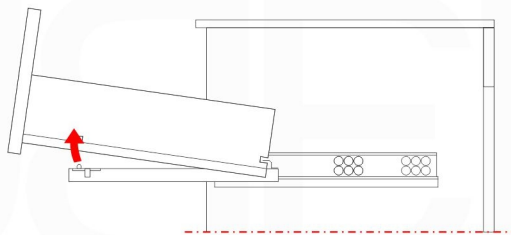
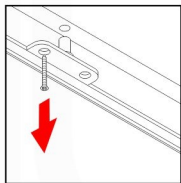

### INSTALL DRAWERS

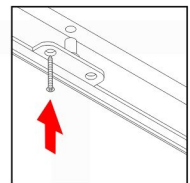
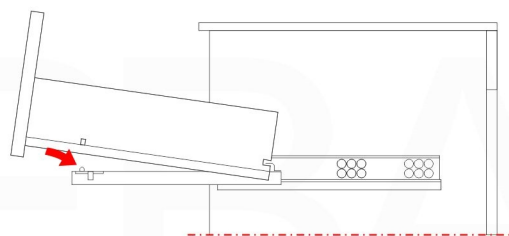
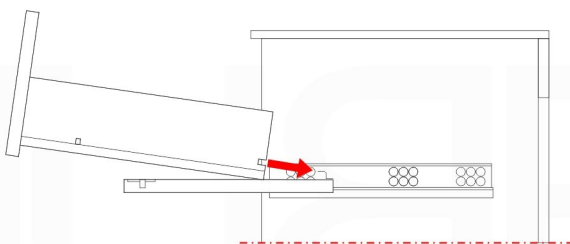



## Pop-Up / P-trap Installation Instructions INSTALLATION GUIDE

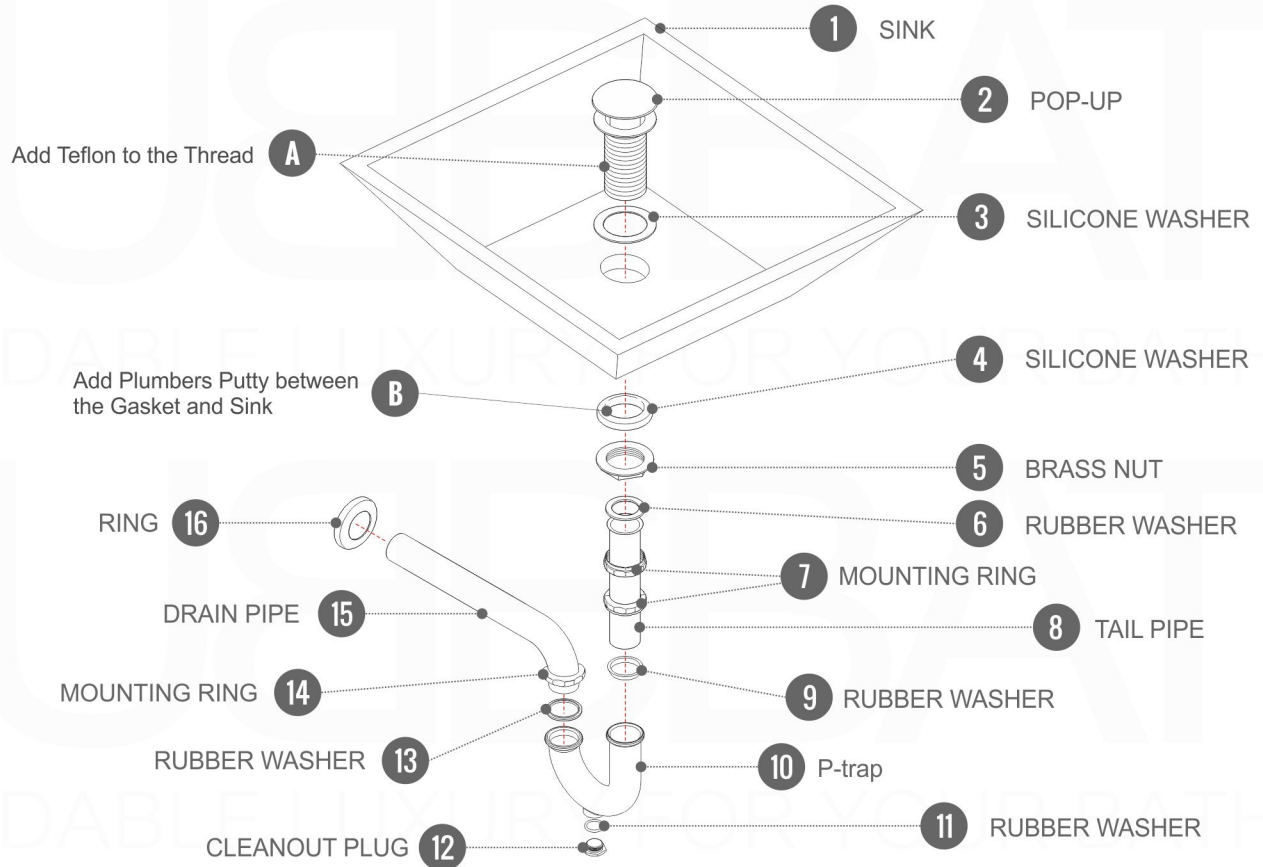

FOR SINKS WITHOUT OVERFLOW  
#SKU: P101N / P102N

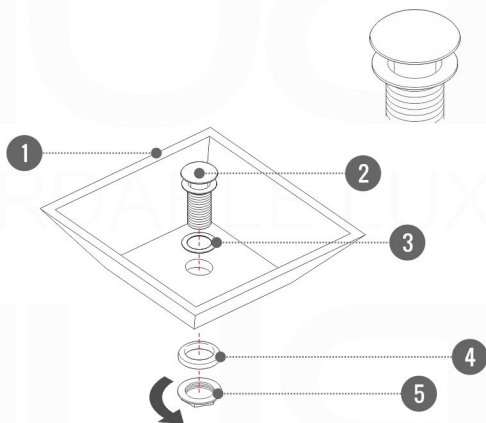

FOR SINKS WITHOUT OVERFLOW  
#SKU: P101 / P102

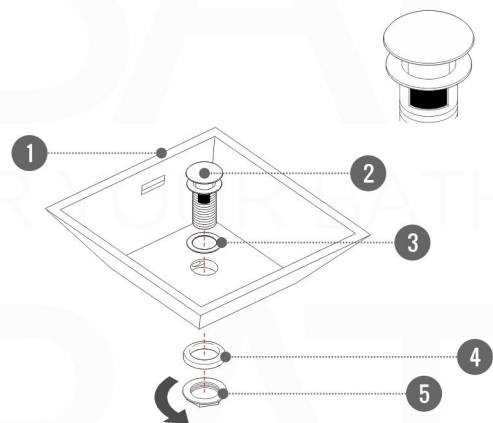

OR