

LOUVRE MLFS-653SB

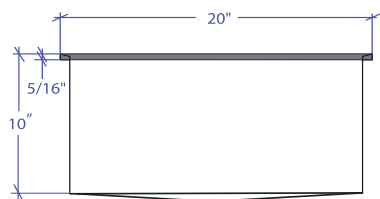

*Flush-Mount Installation Kit is included with each sink
*Custom ADA compliant versions are available

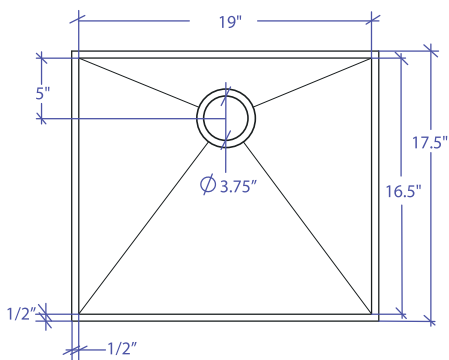

• FEATURES

- 16-gauge type 304 stainless steel
- Hollow 304 stainless steel support beam
- Bevel basin design

• TECHNICAL INFORMATION

- External dimension: 20"Lx17.5"Wx10"D
- Basin dimensions: 19"Lx16.5"Wx10"D
- Frame width: 1/2"
- Frame thickness: 5/16"

• FINISHES

- Satin Brushed stainless steel

• INSTALLATION OPTIONS

- Flush-mount

• MINIMUM CABINET SIZE (I.D.)

- Flush-mount 22"

• INDUSTRY'S ONLY STAINLESS STEEL SINK DESIGNED SPECIFICALLY TO BE FLUSH-MOUNTED

• INTERNATIONAL PATENT PENDING

• FLUSH-MOUNT INSTALLATION

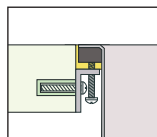

Flush-mount

• ACCESSORIES

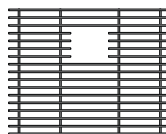

MBG-6506SB
Basin Grid

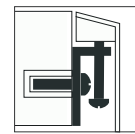

Flush Mount Kit
(Included)
MTK-616AL

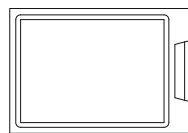

MCB-651BB
Cutting Board

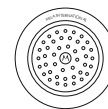

MKD-101SB
Strainer

PROJECT INFORMATION			
Project			
Date	/ /	QTY	
Specifier			
Contact			
Note			