

ORION MOUD-803SB



*Custom ADA compliant sinks are available

• FEATURES

16-gauge type 304 stainless steel
Bevel basin design

• TECHNICAL INFORMATION

External dimension: 33"Lx20"Wx10"D
Basin dimensions:
Left: 17"Lx18"Wx10"D
Right: 13"Lx18"Wx10"D

• FINISHES

Satin Brushed stainless steel

• INSTALLATION OPTIONS

Top-mount
Under-mount

• MINIMUM CABINET SIZE (I.D.)

Top-mount 34"
Under-mount 36"

• US DESIGN PATENT D618,324 S

• DUAL-MOUNT INSTALLATION

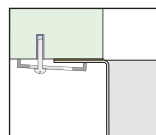

Under-mount

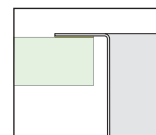

Top-mount

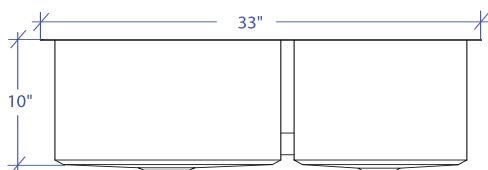
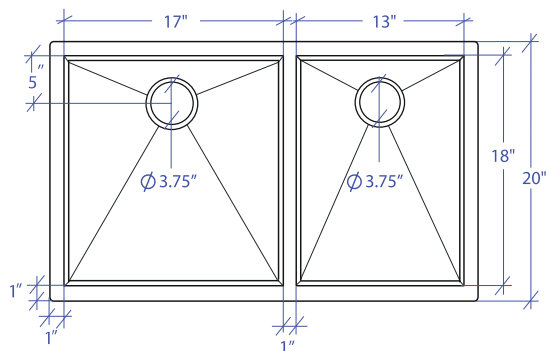

• ACCESSORY OPTIONS

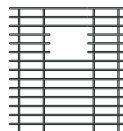

MBG-083SB
Basin Grid

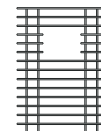

MBG-082SB
Basin Grid

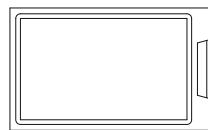

MCB-801BB
Cutting Board

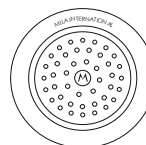

MKD-101SB
Strainer

PROJECT INFORMATION

Project			
Date	/ /	QTY	
Specifier			
Contact			
Note			