

# FLATIRON MUS-653SB

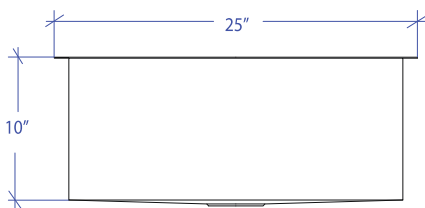

\*Custom ADA compliant versions are available

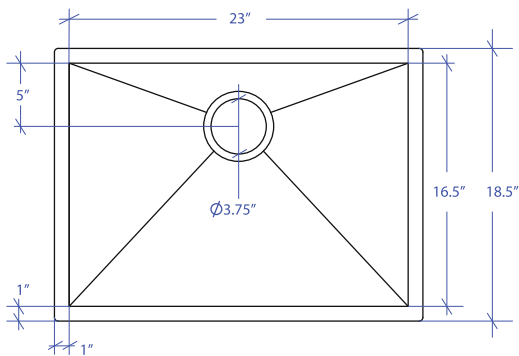

## • FEATURES

16-gauge type 304 stainless steel  
90° zero radius design

## • TECHNICAL INFORMATION

External dimension: 25"Lx18.5"Wx10"D  
Basin dimensions: 23"Lx16.5"Wx10"D

## • FINISHES

Satin Brushed stainless steel

## • INSTALLATION OPTIONS

Top-mount  
Under-mount

## • MINIMUM CABINET SIZE (I.D.)

Top-mount 26"  
Under-mount 28"

## • DUAL-MOUNT INSTALLATION

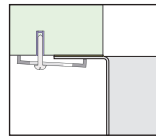

Under-mount

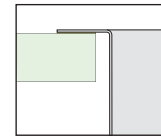

Top-mount

## • ACCESSORY OPTIONS

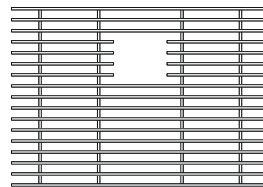

MBG-6509SB  
Basin Grid

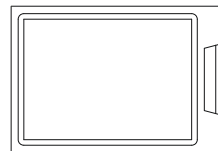

MCB-651BB  
Cutting Board

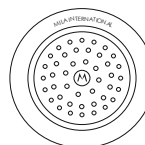

MKD-101SB  
Strainer

### PROJECT INFORMATION

Project			
Date	/ /	QTY	
Specifier			
Contact			
Note			