

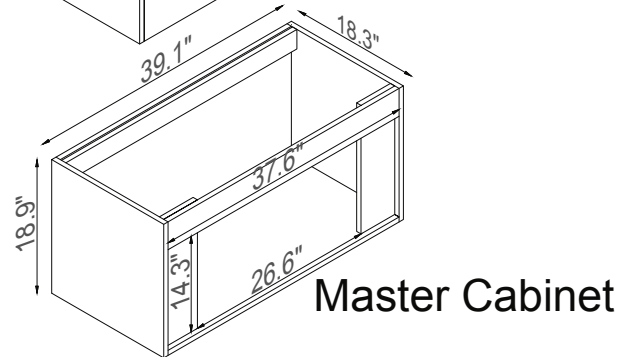

Streamline

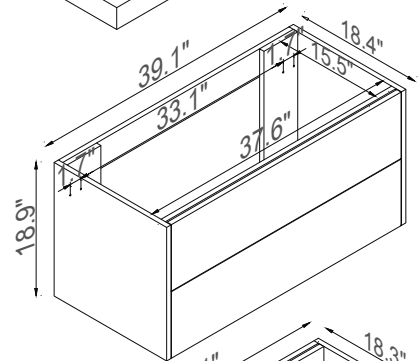
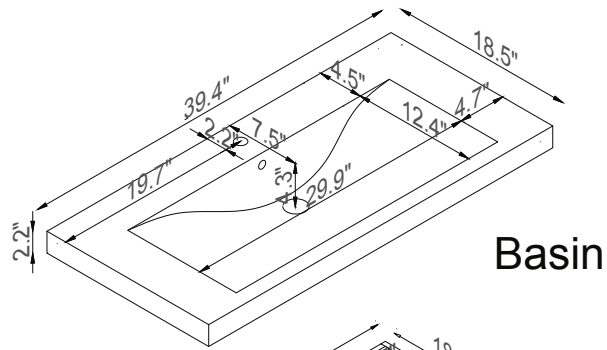
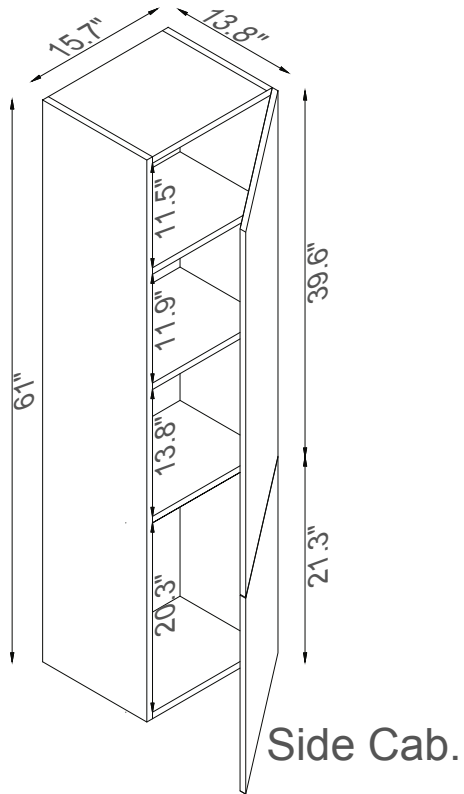

K1500-098-40-511S