

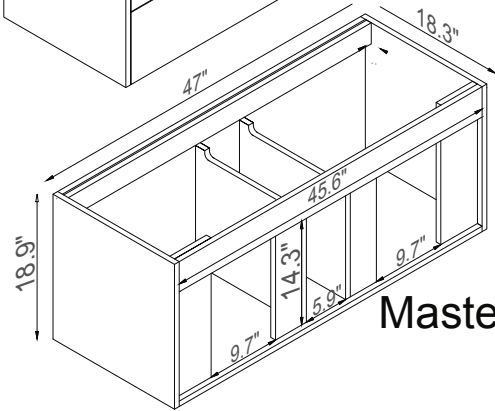

Streamline

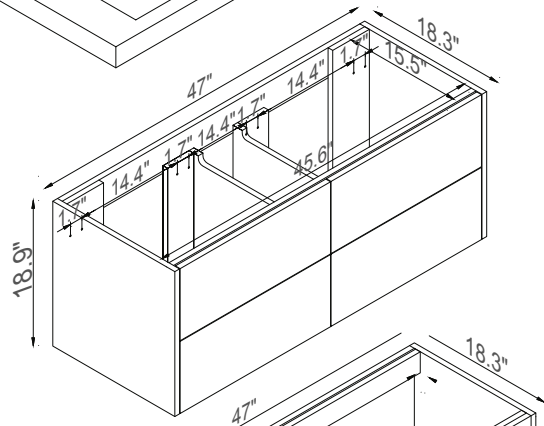
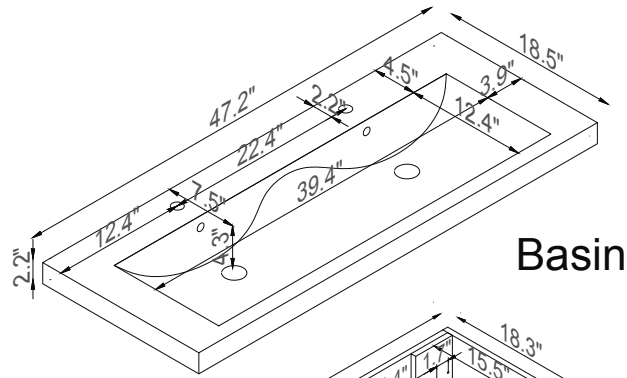
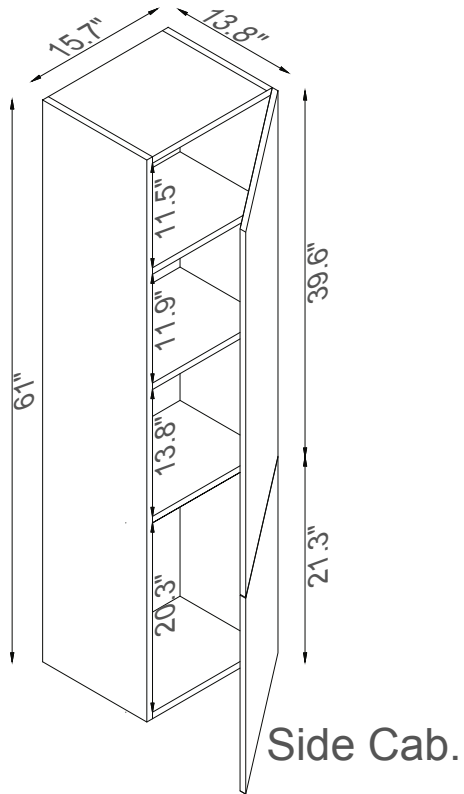

K1500-098-48-511S