

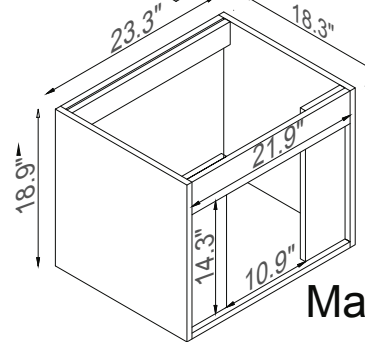

Streamline

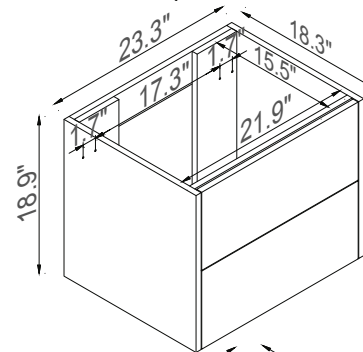
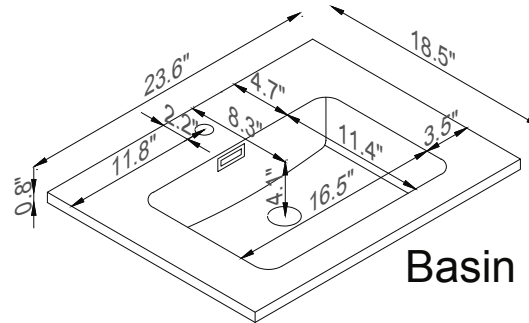
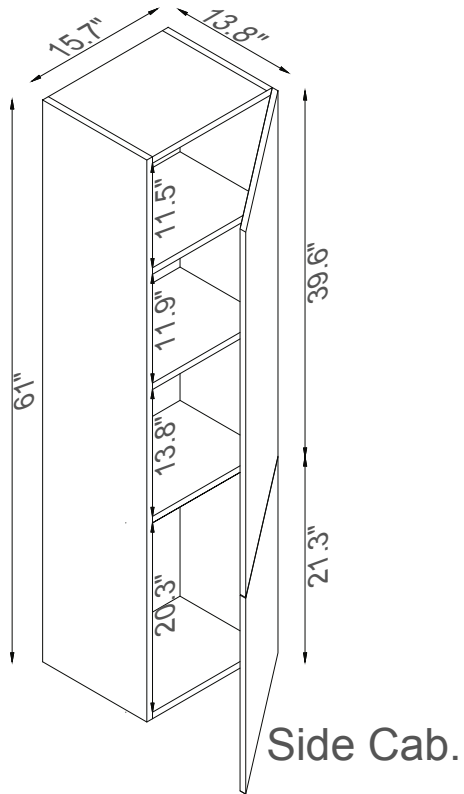

Master Cabinet

K1500-161-24-511S