

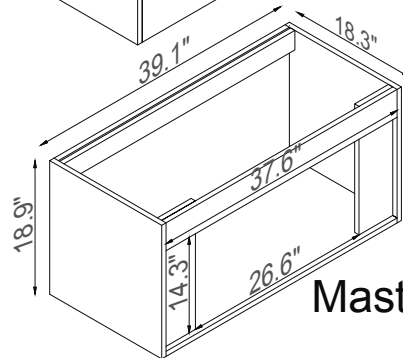

Streamline

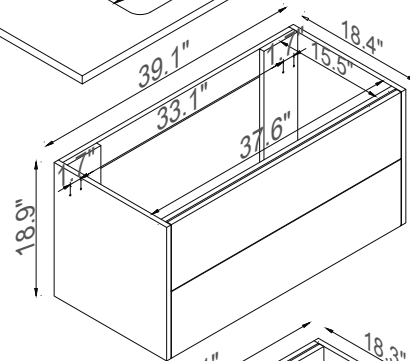
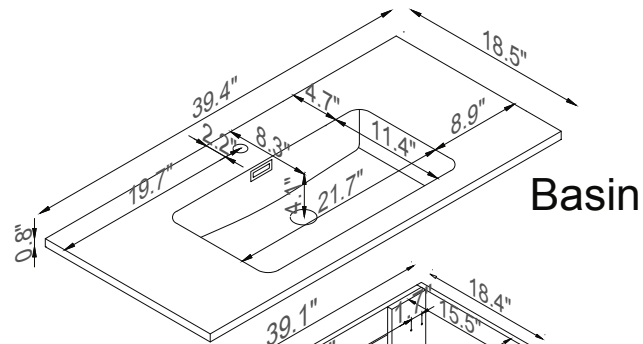
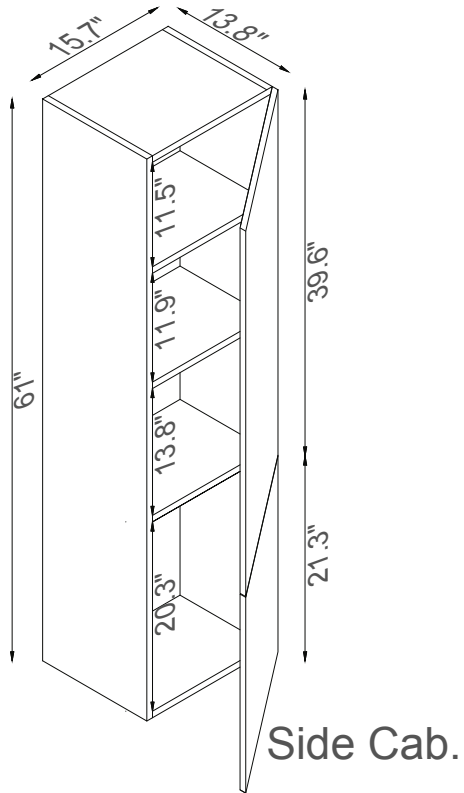

K1500-161-40-511S