

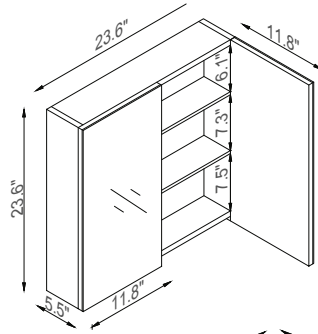

Streamline

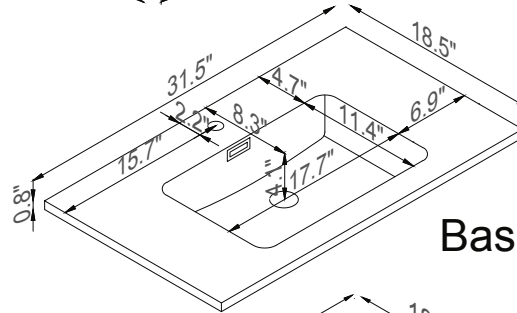

Med. Cab.



Basin

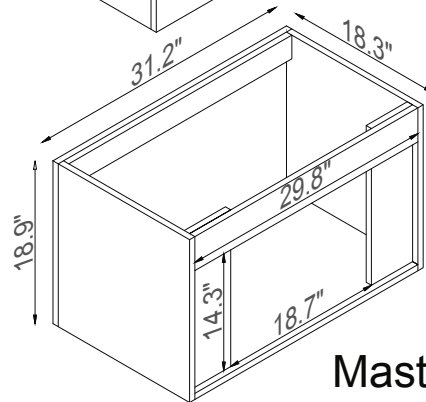
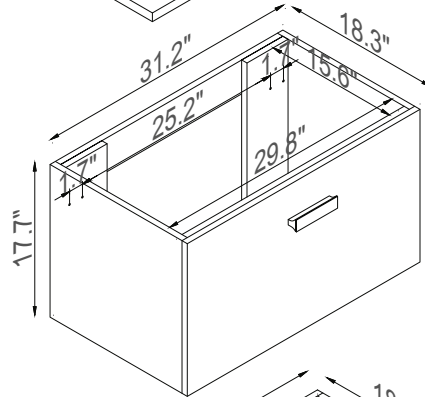

Master Cabinet

K1801-161-32-51MR