

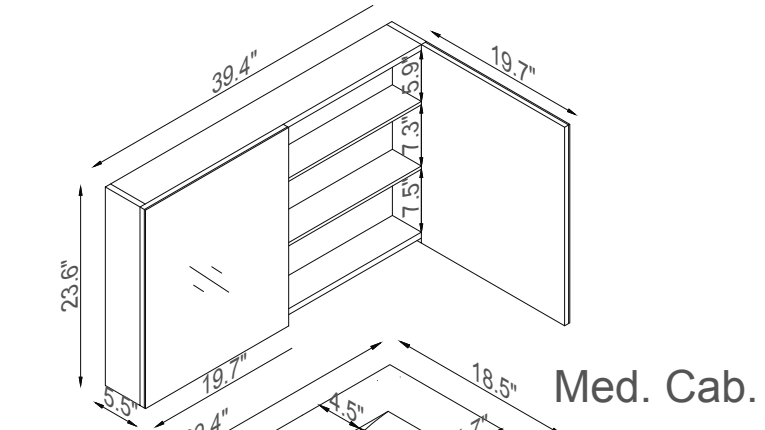

Streamline

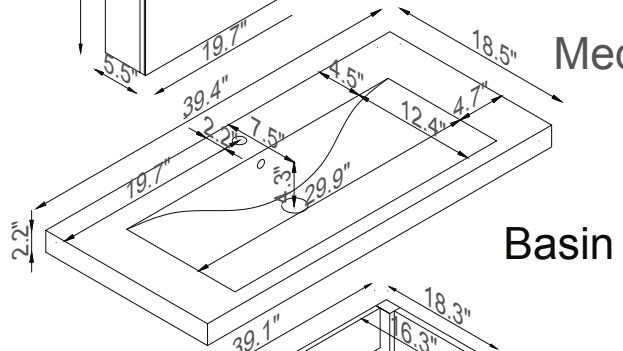

Med. Cab.



Basin

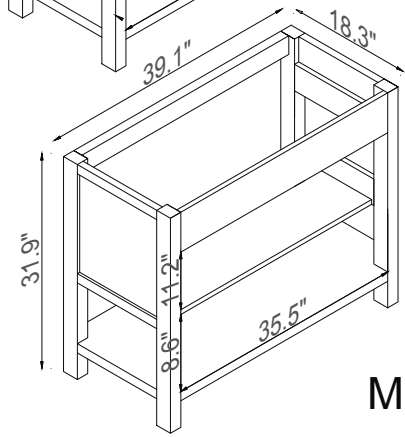
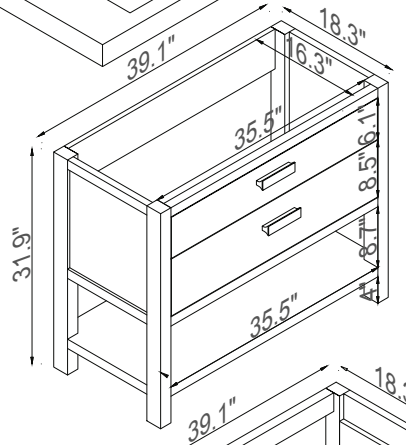

Master Cabinet

K1803-098-40-55MR