

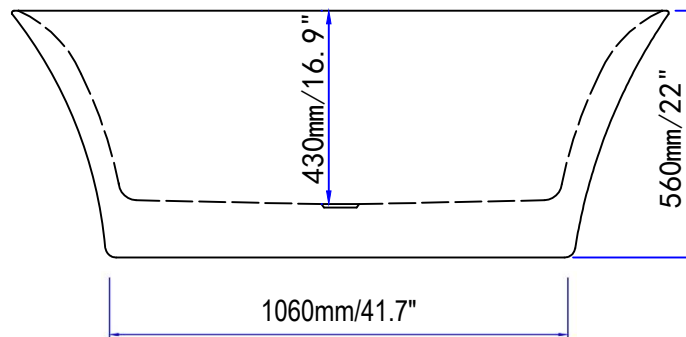

Streamline

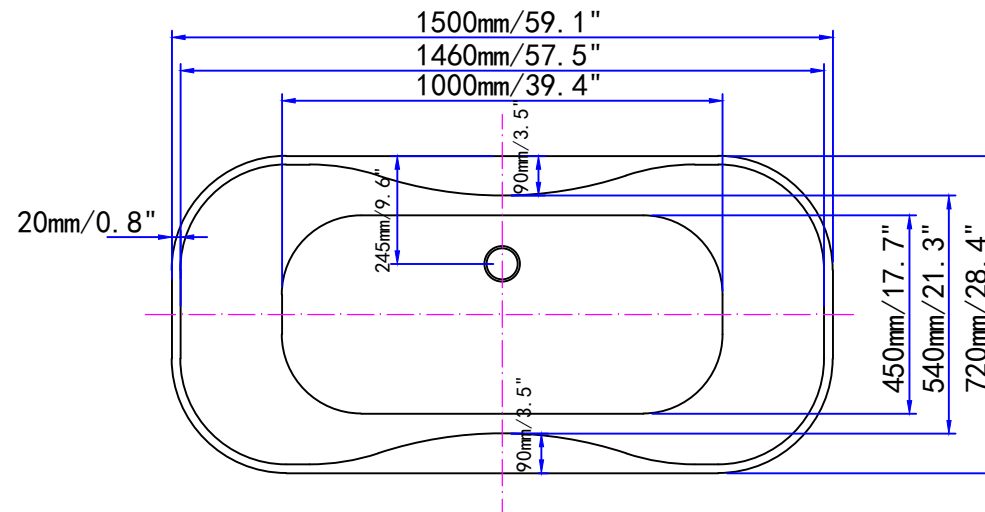

N-1060-59FSWH-FM

