

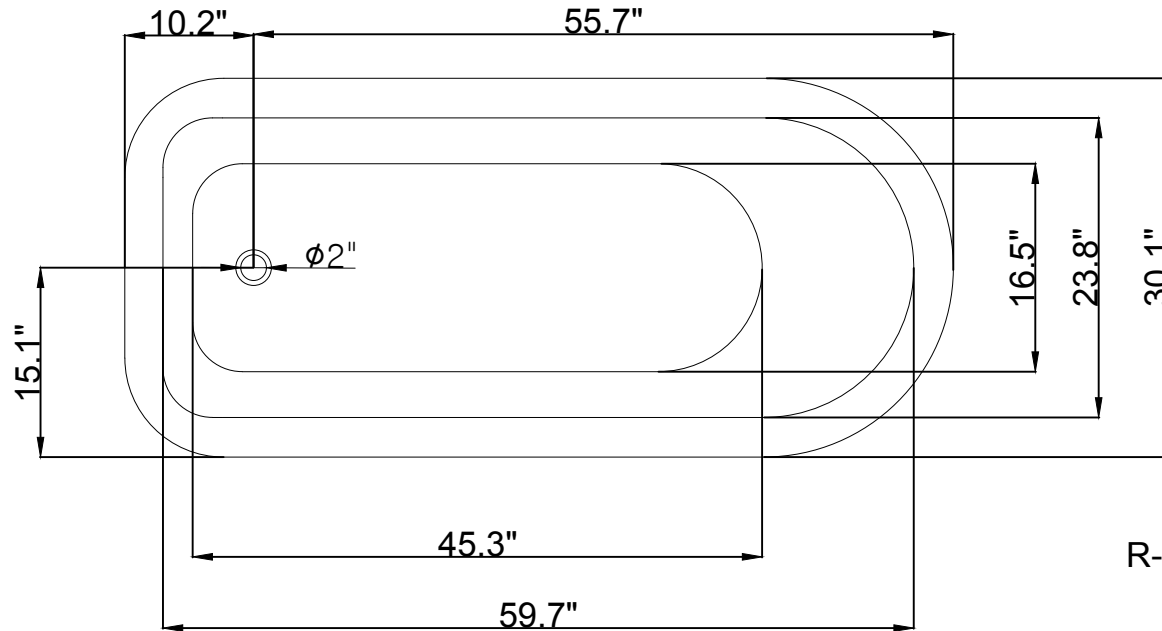

Streamline

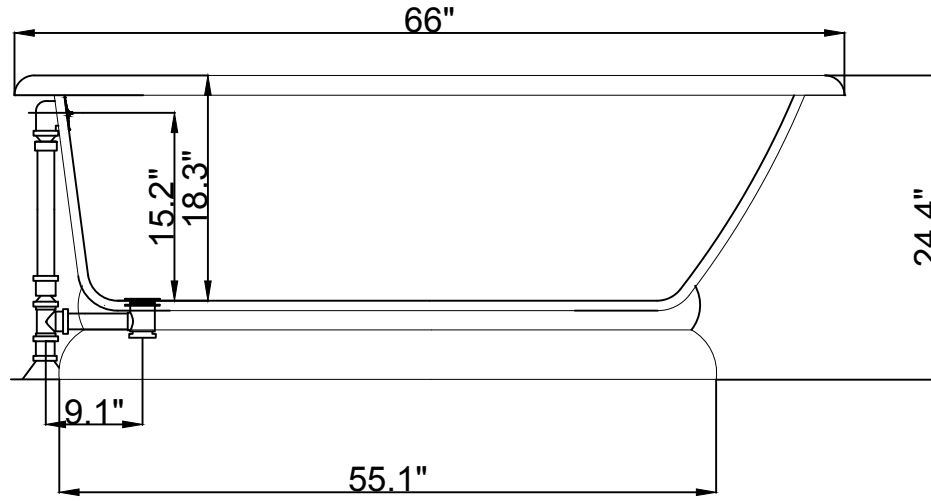

R-5140-66CIFS WH-FM

