

PART NO. D12119

SPECIFICATION SHEET

Brass 1/2 in. IPS Nipple

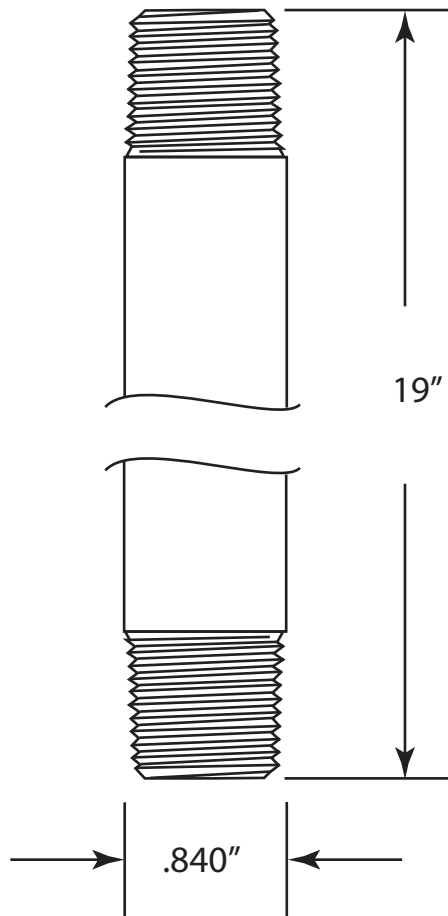

0.109" Wall
Thickness

