

ZLINE

ATTAINABLE LUXURY[®]

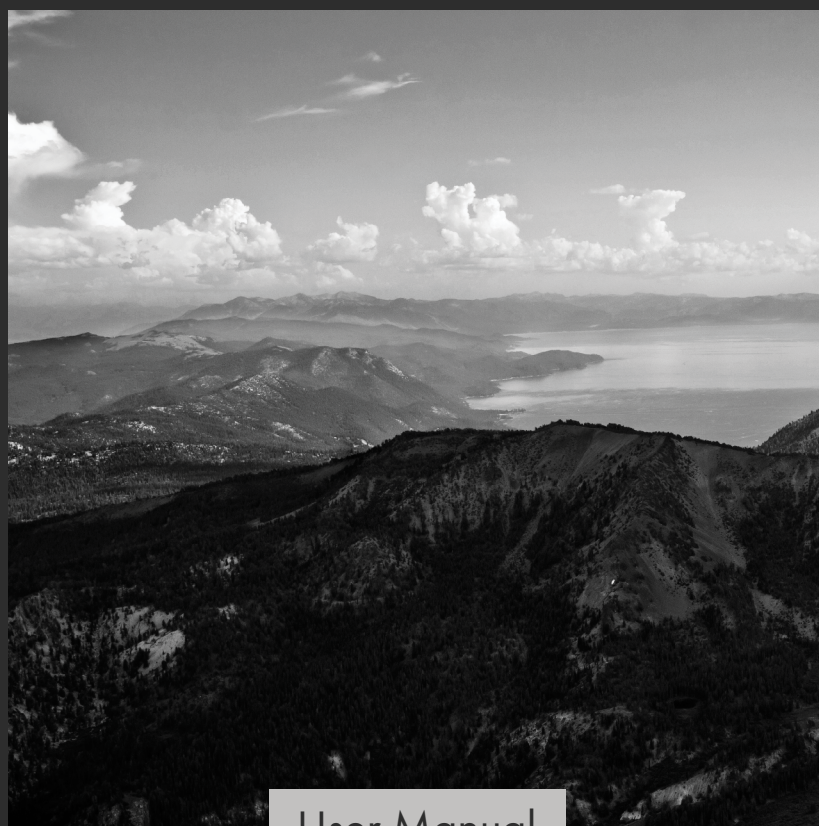

User Manual

MONUMENT DISHWASHER

www.zlinekitchen.com



ZLINE Kitchen and Bath provides Attainable Luxury, where the kitchen and bath of your dreams is never out of reach. Through our unique designs and unparalleled quality, we're dedicated to providing you an elevated experience in the heart of your home. With an endless selection of features and finishes, our inspiration is your reality.

ZLINE
ATTAINABLE LUXURY®



ZLINE is fueled by a passion for innovation; A relentless pursuit of bringing the highest end luxury designs and professional features into everyone's homes. Because we continually strive to improve our products, we may change specifications and designs without prior notice.

⚠ WARNING: This product can expose you to chemicals including nickel, which is known to the State of California to cause cancer. For more information, go to www.P65Warnings.ca.gov.

TABLE OF CONTENTS

IMPORTANT SAFETY INSTRUCTIONS	1
OPERATION	6
MAINTENANCE AND CLEANING	20
TROUBLESHOOTING	25
WARRANTY	30

IMPORTANT SAFETY INSTRUCTIONS



CAUTION
RISK OF ELECTRIC SHOCK
DO NOT OPEN



This symbol indicates that dangerous voltage constituting a risk of electric shock is present within your refrigerator.



This symbol indicates that there are important operating and maintenance instructions in the literature accompanying your refrigerator.

BEFORE YOU BEGIN

Read these instructions completely and carefully.

IMPORTANT

- Observe all governing codes and ordinances.
- Note to Installer – Be sure to leave these instructions for the consumer's and local inspector's use.
- Note to Consumer – Keep these instructions with your User Guide for future reference.
- Skill Level – Installation of this dishwasher requires basic mechanical and electrical skills. Proper installation is the responsibility of the installer. Product failure due to improper installation is not covered under the appliance warranty.
- Completion Time – One to three hours. New installations require more time than replacement installations.

IMPORTANT

- The dishwasher **MUST** be installed to allow for future removal from the enclosure if service is required.
- If you received a damaged dishwasher, you should immediately call customer service.

IMPORTANT SAFETY INSTRUCTIONS

FOR YOUR SAFETY

Read and observe all CAUTIONS and WARNINGS shown throughout these instructions. While performing installations described in this booklet, gloves and safety glasses or goggles should be worn.

WARNING

This dishwasher comes with a heating element to heat the water. To avoid the risk of a serious burn, don't touch the heating element when the dishwasher is on.



To reduce the risk of electrical shock, fire, or injury to persons, the installer must ensure that the dishwasher is completely enclosed at the time of installation.

SPECIFICATIONS	
Dimensions (W x D x H)	<ul style="list-style-type: none">• Unit with decorated door and handle: 23.9 x 26.5 x 33.7 in.• Unit without decorated door and handle: 23.9 x 24 x 33.7 in.

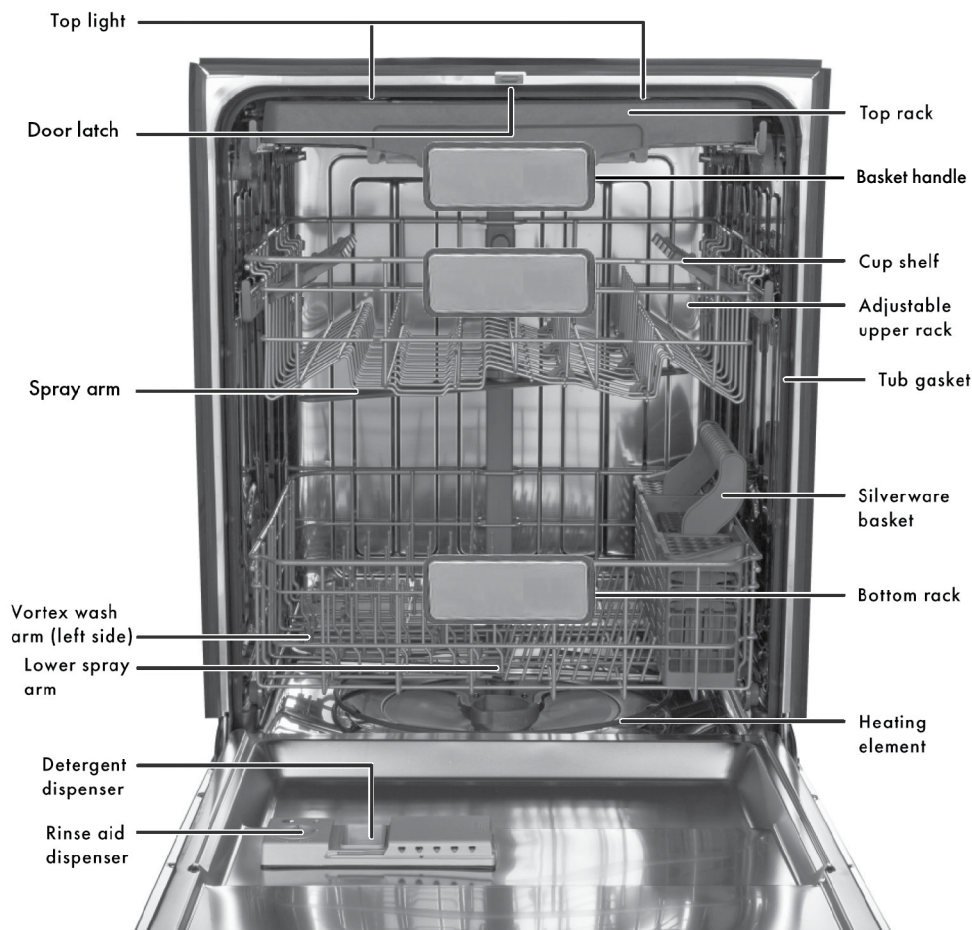

IMPORTANT SAFETY INSTRUCTIONS



CAUTION
RISK OF ELECTRIC SHOCK
DO NOT OPEN



This symbol indicates that dangerous voltage constituting a risk of electric shock is present within your dishwasher.



This symbol indicates that there are important operating and maintenance instructions in the literature accompanying your dishwasher.

WARNING

When using your dishwasher, follow basic safety precautions, including the following:

BEFORE YOU BEGIN

Read these instructions completely and carefully.

1. Read these instructions.
2. Keep these instructions.
3. Heed all warnings.
4. Follow all instructions.
5. Clean only with a damp cloth.
6. Do not block any ventilation openings. Install in accordance with the manufacturer's instructions.
7. Make sure that the available AC power matches the voltage requirements of this appliance.
8. Refer all servicing to qualified service personnel. Servicing is required when the appliance has been damaged in any way or it does not operate normally.



Electric Shock Hazard

Failure to follow these instructions can result in electric shock, fire, or death.

1. **WARNING-DANGER** Never allow children to play with, operate, or crawl inside the dishwasher.
2. Turn off the dishwasher before carrying out user maintenance on it.
3. If a component part is damaged, it must be replaced by the manufacturer, its service agent, or similar qualified persons in order to avoid a hazard.
4. This appliance is intended to be used in household and similar environments.

IMPORTANT SAFETY INSTRUCTIONS

BASIC PRECAUTIONS BEFORE USE:

- Read all instructions before using the dishwasher.
- The manual does not cover every possible condition and situation that may occur.
- Use the dishwasher only for intended function as described in this manual.
- To ensure the longevity of the dishwasher's optimal wash performance, we recommend rinsing off any large pieces of food from your dishes prior to placing it in the unit for a wash cycle.
- When loading items to be washed:
 - Load sharp items and knives so that they are not likely to damage the door seal and tub.
 - Load sharp items and knives with the handles up to reduce the risk of cut-type injury.
- Do not wash plastic items unless they are marked dishwasher safe or the equivalent, if not marked, check with manufacture for recommendation, items that are not dishwasher safe may melt and create a potential fire hazard.
- If the dishwasher drains in to a garbage disposal, make sure disposal is completely empty before running dishwasher.
- Do not tamper with the controls.
- Do not operate your dishwasher unless all enclosure panels are properly in place.
- Do not touch the heating element during or immediately after use, especially if the sanitize option has been selected.
- Do not let children abuse, sit, or stand on door or racks of the dishwasher.
- Under certain conditions, hydrogen gas may be produced in a hot water system that has not been used for two weeks or more. **HYDROGEN GAS IS EXPLOSIVE.**
- If the hot water system has not been used for a period of time, before using it again, let the water flow for several minutes. This will release any accumulated hydrogen gas. Hydrogen gas is flammable. Do not smoke or use an open flame during this time.
- Do not store or use combustible materials, gasoline or other flammable vapors and liquids in the vicinity of this or any other appliance.
- Use only detergents or rinse agents recommended for use in a dishwasher and keep them out of the reach of children.

IMPORTANT SAFETY INSTRUCTIONS

- Keep young children and infants away from dishwasher when it is operating.
- Do not use the dishwasher if it has a damaged power line or plug, and do not plug the dishwasher into a damaged outlet, failure to observe these instructions may result in electrical shock.
- Remove the door to the washing compartment when removing an old dishwasher from service or discarding it.
- To reduce the risk of injury, do not allow children to play in or on a dishwasher.

SAVE THESE INSTRUCTIONS

OPERATION

1. Water supply temperature should be between 120° F and 150° F.
2. Dispose of the discarded appliance and packing material properly.
3. The dishwasher must be grounded or it can result in a risk of electric shock.
4. If there is any damage to the dishwasher, please contact customer service at 614-777-5004. Do not attempt to repair or replace any part by yourself. For information on installing and setting up your dishwasher, refer to the Installation Guide provided.

BEFORE USING YOUR DISHWASHER

1. Remove the interior packing.
2. Clean the interior surface with lukewarm water using a soft cloth.

FINDING A SUITABLE LOCATION

- This dishwasher is designed to be built-in.
- The dishwasher door must be able to swing fully open.

PROVIDING A PROPER POWER SUPPLY

Check your local power source. This dishwasher requires a 120V, 60Hz power supply.

Refer to the Installation Guide for additional information.

HOW YOUR DISHWASHER CLEANS

The dishwasher fills with water, covering the filter area at the bottom. Water is then pumped through the various filter and spray arms, spraying a mixture of hot water and detergent against the soiled surfaces of your dishes and silverware. Soil particles are separated and go down the drain as the dirty water is drained and replaced with clean water. The number of water fills is determined by the cycle selected.

WASH CYCLE SELECTIONS

Cycle times are approximate and will vary with options selected. Hot water is necessary to activate dishwasher detergent and melt fatty food soils. An automatic sensor checks the incoming water temperature and, if it is not hot enough, the timer will be delayed to allow for the water to heat for the main wash of all cycles. This happens even when hi-temp wash is selected, so that higher temperature will be available to handle heavier soil loads.

OPERATION

FILTER SYSTEM

Your dishwasher has a multiple filter system which includes four separate filter meshes. It separates dirty water and clean water into different chambers. The multiple filter system helps your dishwasher to get better performance with less water and less energy.

SMART WASH SYSTEM

Your dishwasher has a smart wash system under the normal wash program which selects the wash cycle based on how large and how soiled the load, permitting your dishwasher to clean more efficiently every time. When a partial load of lightly soiled dishes is placed in the unit, a short wash cycle is automatically selected. When a full load of heavily soiled dishes is placed in the unit, a heavy wash cycle is automatically selected.

ADJUSTABLE UPPER RACK

The upper rack of your dishwasher can be raised or lowered to accommodate loading dishes of varying heights in either rack. After removing the 3rd rack, the upper rack clearance height can be adjusted from 8" to 10". The lower rack clearance height can be adjusted from 11" to 13". See "Adjusting the Upper Rack" on page 12.

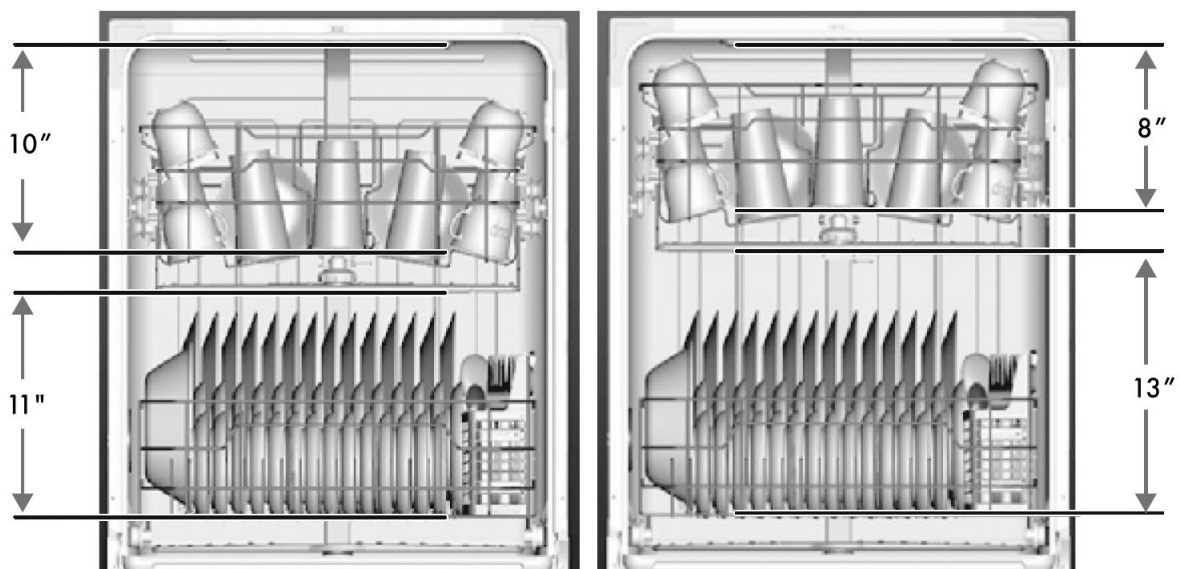

OPERATION

USING THE CONTROL PANEL

Your dishwasher's control panel is located on the top edge of the door. The door must be open to make settings and operate the dishwasher.

POWER On/Off - 3sec - Hold this button down for three seconds to turn the power on or off.

CYCLES

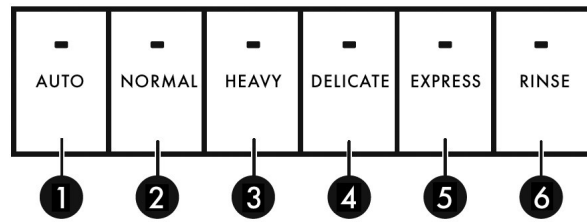

Select a cycle based on the type of dishes to be washed and the level of soil on the dishes. Cycle times are approximate and will vary with options selected. The timer will be delayed to allow for the water to heat for the main wash of all cycles if the sensor detects the water is not hot enough. Below is water use and cycle times under standard conditions.

#	CYCLE	DESCRIPTION	WATER USE	CYCLE TIME (MINUTES)
1	AUTO	Auto sensing wash, lightly, or heavily soiled crockery, with or without dried-on food.	3.0 - 5.9 gal.	100 - 133
2	NORMAL	Use for regularly soiled dinner dishes or silverware.	3.0 - 5.9 gal.	102 - 120
3	HEAVY	Use for hard-to-clean, heavily soiled dishes, pots, and pans.	6.9 gal.	138
4	DELICATE	Use for lightly soiled crockery and glass.	5.9 gal.	114
5	EXPRESS	Use for lightly soiled and pre-rinsed dishes and silverware.	4.0 gal.	60
6	RINSE	Use for pre-rinsing dishes or glasses. This is only a rinse that keeps food from drying on your dishes and reduces odor buildup in your dishwasher until you are ready to wash a full load. Do not use detergent.	2.0 gal.	20

OPERATION

CONTROLS AND INDICATORS

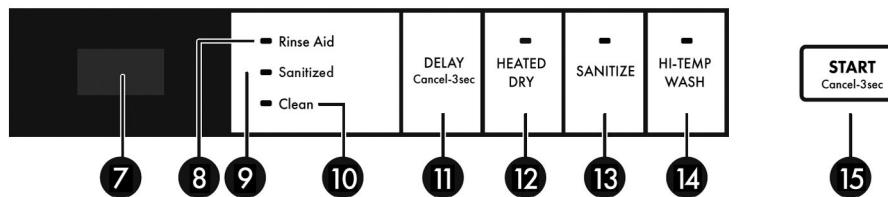

Options can add enhancements to the cycle selected.

7. DISPLAY - Shows the remaining hours and minutes of the current cycle, delay hours remaining, and error codes (see "Error Codes" on page 25).
8. Rinse Aid - Turns on when you need to add rinse aid.
9. Sanitized - Turns on when a sanitized cycle is finished. Turns off after 30 seconds, when the door is opened.
10. Clean - Turns on after a cycle finished. Turns off after 30 seconds when the door is opened.
11. DELAY - Press repeatedly to delay the start of the selected wash cycle until the delay time you want is shown on the display. "H" will show. This is not an error code. You can select from one to 24 hours delay. After you select the delay time you want, press START/CANCEL once, then close the door within four seconds. The delay begins to count down. If you open the door while delay is running, press the START/CANCEL, then close the door within four seconds to begin the cycle from that point. To cancel the delay and begin the cycle before the delay period is complete, open the door, then press and hold DELAY for three seconds.

OPTIONS

12. HEATED DRY - Use to heat-dry your dishes. This function is not available for rinse only cycle.
13. SANITIZE - Use to sanitize your dishes and glassware. Maintains the water temperature at 158° F max., and is available with the AUTO, NORMAL, and HEAVY cycles.

Note:

- Certified residential dishwashers are not intended for licensed food establishments.

OPERATION

14. HI TEMP WASH - Use to maintain the water temperature at 140° F max. This option is available with the AUTO, NORMAL, and HEAVY cycles.
15. START/CANCEL - Press to start the dishwasher after you have selected a cycle and function (if desired). Close the door. The cycle indicator begins to blink and the function indicator turns on. If you don't close the door within four seconds of pressing START/CANCEL, the dishwasher pauses. Press START/CANCEL again to continue with the cycle. To cancel a running cycle, open the door, then press and hold START/CANCEL for three seconds. The dishwasher will return to standby status. To load more dishes or pause the dishwasher while it's already running, open the door. A safety mechanism stops the cycle.



To avoid injury open the door slowly and carefully. There is a possibility of hot steam from inside the dishwasher.

You can add more dishes before the main wash cycle has started. To determine this, check the detergent dispenser in the door. If the detergent dispenser is still closed, you can add more dishes. If it is open, you can add dishes to the dishwasher if the dish quantity is small. If the quantity is large, restart the cycle.

BASIC OPERATION

1. Load the dishwasher (See "Preparing and Loading Dishes" on page 11).
2. Add detergent (See "Filling the Detergent Dispenser" on page 17).
3. Add rinse aid, if needed (See "Filling the Rinse Aid Dispenser" on page 18).
4. Select the cycle you want (See the "Basic Operation" on page 10). The indicator will light when the selection is made.
5. Select the function you want. The indicator will light when the selection is made.
6. To start, press START/CANCEL on the control pad.
7. Close the door within four seconds and the wash cycle will begin.

OPERATION

PREPARING AND LOADING DISHES

Preparing dishes for washing

- Scrape away large pieces of food, bones, pits, toothpicks, and similar items. The continuous filtered wash system will remove the remaining food particles.



- Burned-on foods should be loosened before loading.
- Empty liquids from glasses and cups.
- Foods such as mustard, mayonnaise, vinegar, lemon juice, and tomato-based products may cause discoloration of stainless steel and plastics if allowed to sit for a long period of time. Unless the dishwasher is to be operated at once, it is best to rinse off these types of foods.
- If the dishwasher drains into a garbage disposal, be sure the disposal is completely empty before starting dishwasher.

OPERATION

ADJUSTING THE UPPER RACK

This dishwasher has a convenient top rack for silverware, cutlery, and small items. This rack can be adjusted to accommodate varying loads, as shown below.

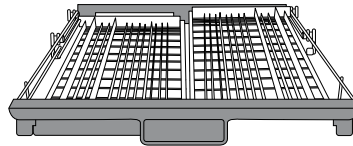

Left rack in lower position and right rack angled

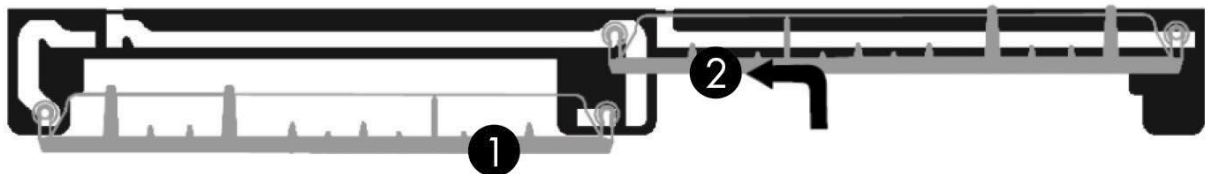

Left rack adjusted to lower position and right rack to upper position



Left rack adjusted to lower position and right rack moved to the left



Left rack adjusted to lower position and right rack removed

OPERATION

ADJUSTING THE UPPER RACK

The height of the upper rack can be adjusted to accommodate loading taller dishes in either rack.

1. Lift the rack to move it to the upper position.

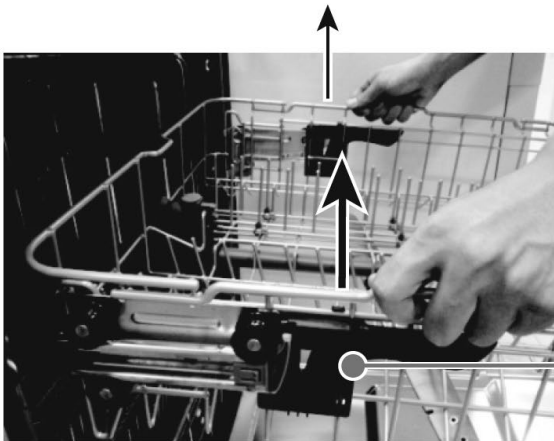

Upper rack in the upper position

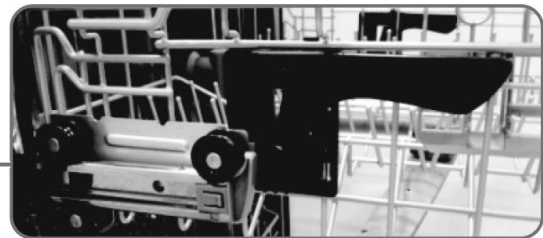

2. Press the handle to move it to the lower position.



Upper rack in the Lower position



LOADING THE UPPER RACK

The upper rack is designed for cups, glasses, small plates, bowls, and plastic items marked dishwasher-safe. For best results, place the items with the soiled surface facing down or toward the center. Tilt them slightly for better drainage.

Note:

Make sure the loaded dishes do not interfere with the rotation of the middle spray arm, which is located just below the upper rack. You can check this by rotating the middle spray arm by hand.

OPERATION

LOADING THE TOP RACK

You can place the items in the top rack randomly or in an orderly fashion. The image below shows how to load the top rack for 16 place settings:

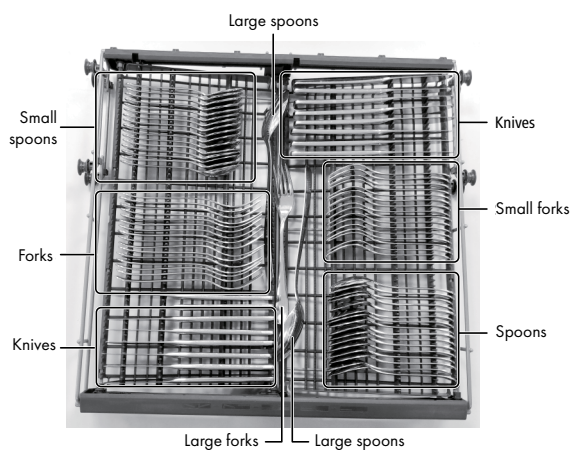

Loading suggestions are shown below.

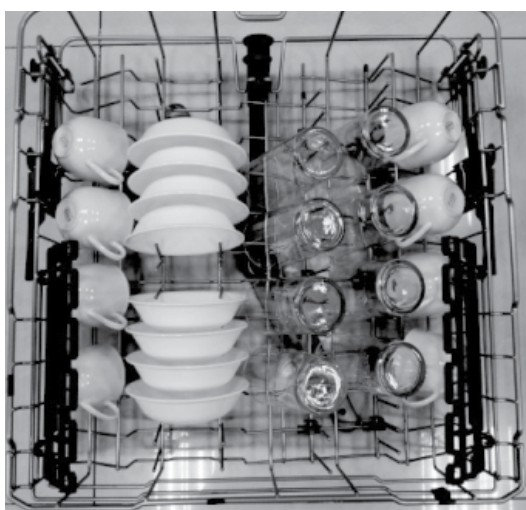

8 place settings

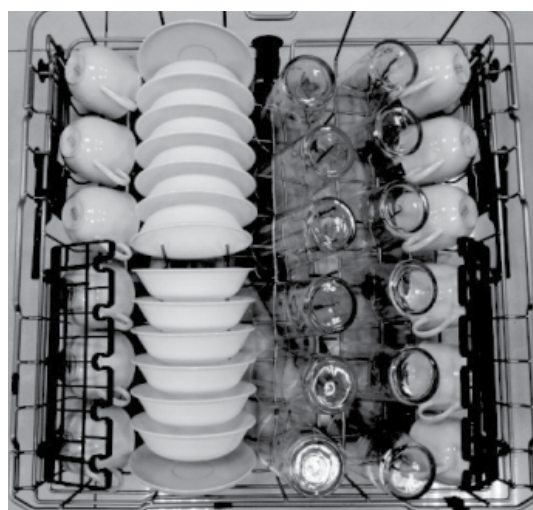

12 place settings

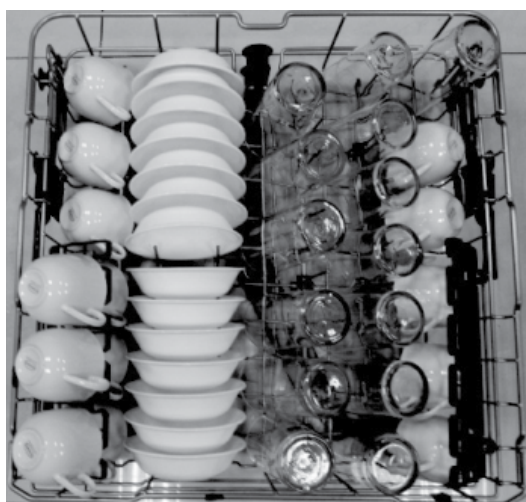

14 place settings

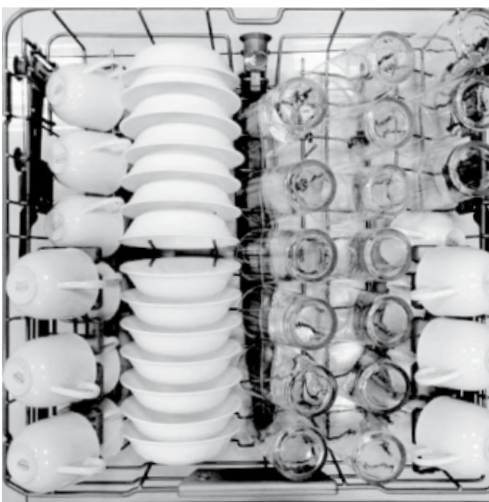

16 place settings

OPERATION

LOADING THE BOTTOM RACK

The bottom rack is designed to accommodate plates, bowls, saucers, and cookware. The adjustable rack lets you load items up to 13 inches high. Large items should be placed along the edge, with the inside faces down, so they do not interfere with the middle or lower spray arms or prevent the detergent dispenser from opening.

The fold-down tines on the bottom rack are provided to support extra large and hard-to-fit items. The tines may be left up for normal use or folded down for more flexible loading of larger items.

Loading suggestions are shown below:

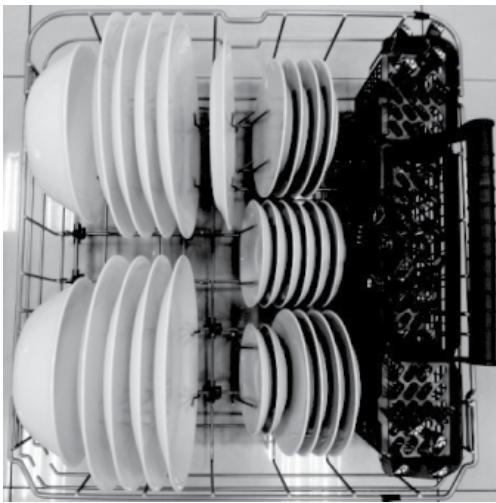

8 place settings



12 place settings

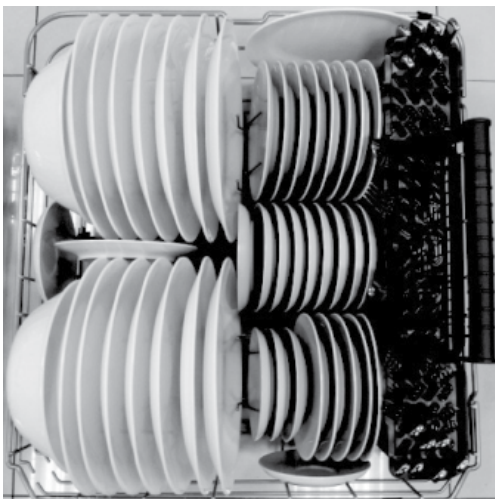

14 place settings

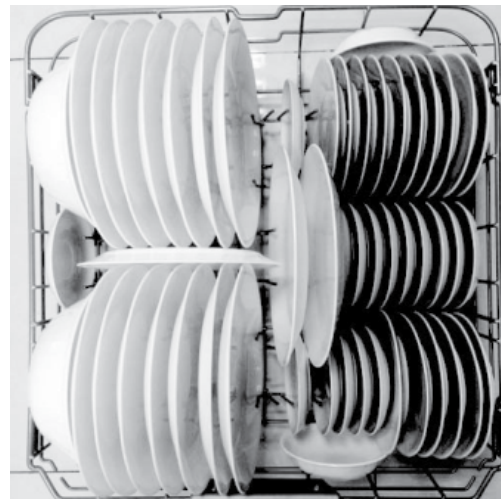

16 place settings

OPERATION

LOADING THE SILVERWARE BASKET

The silverware basket is divided into three separate sections, which can be placed in either the upper or lower racks.

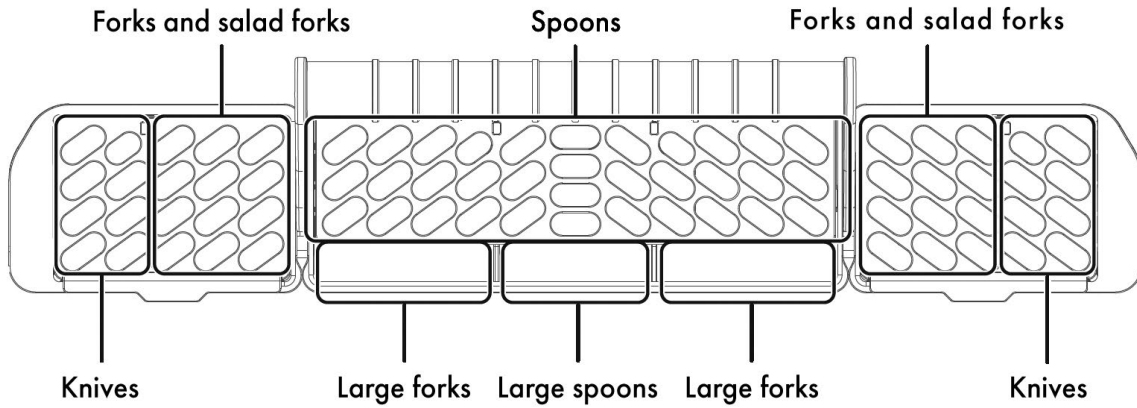

Caution:

Make sure that nothing protrudes through the bottom of the silverware basket to block the lower spray arm.

ADDING A DISH

The silverware basket is divided into three separate sections, which can be placed in either the upper or lower racks.

Caution:

TO AVOID BURN INJURY: Open the door slowly and wait until the spray arms and wash action stop. Hot water may splash out of dishwasher. Failure to do so may result in injury.

Before adding dishes, refer to "Preparing and Loading Dishes" on page 11 for instructions on loading more dishes. Also see information on START/CANCEL in the "Controls and Indicators" section on page 9. To add or remove items after the wash cycle starts:

1. Open the door slightly and wait a few seconds until wash action stops before completely opening.
2. Add the item.
3. Press START/CANCEL on the control pad and close the door within four seconds. The cycle automatically resumes.

OPERATION

FILLING THE DETERGENT DISPENSER

1. Push the detergent dispenser cover latch downwards to open the detergent cup.

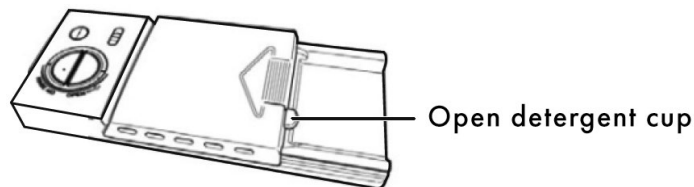

2. Add detergent (dry powder, liquid, or packets) to the cup.

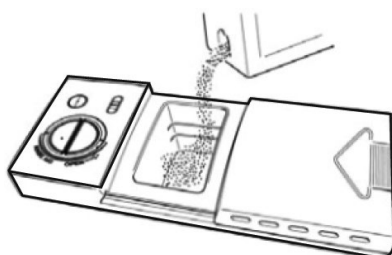

3. Close the detergent dispenser cover.

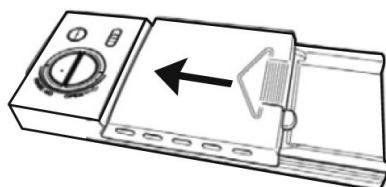

The amount of detergent required depends on the cycle selected and the soil level on the dishes. Refer to the following table for the recommended amount. Loading suggestions are shown below:

Note: Pods are not designed for this dispenser. They should be thrown into the bottom of the tub.

CYCLE	SOFT WATER (0-3 GRAINS)	MEDIUM HARD WATER (4-8 GRAINS)	HARD WATER (9-12 GRAINS)	VERY HARD WATER (OVER 12 GRAINS)
AUTO NORMAL HEAVY DELICATE EXPRESS	2 tsp. (main wash cup 1/4 full)	5 tsp. (main wash cup fill to line above regular)	8 tsp. (main wash cup completely full)	Main wash cup completely full (water softener recommended)
RINSE	No detergent	No detergent	No detergent	No detergent

OPERATION

FILLING THE RINSE AID DISPENSER

Your dishwasher is designed to use a liquid rinse aid. The use of rinse aid greatly improves drying performance after the final rinse. Do not use a solid or bar-type rinse aid. Under normal conditions, the rinse aid will last approximately one month. Try to keep the dispenser full, but do not over fill it.

1. Turn rinse aid dispenser cap 1/4 turn counterclockwise and lift it out.

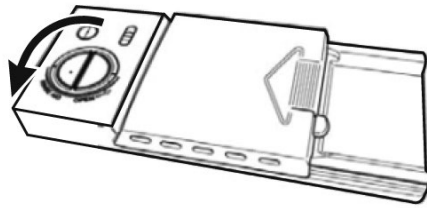

2. Add rinse aid until liquid touches the indicated fill level. Do not overfill since this can cause over sudsing. Wipe up any spills with a damp cloth. The dispenser holds enough for 35 to 140 washes, depending on the dial setting.

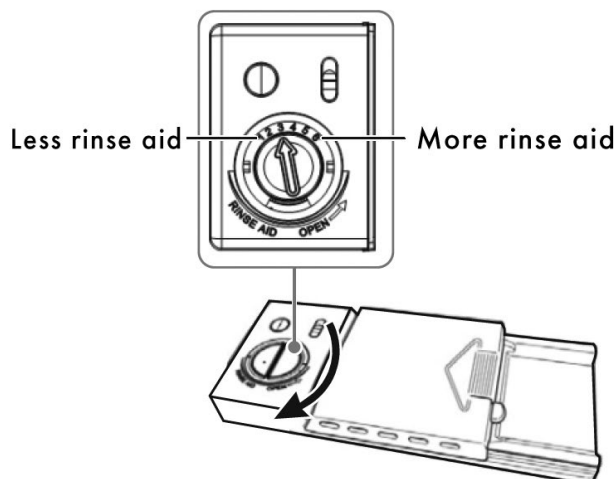
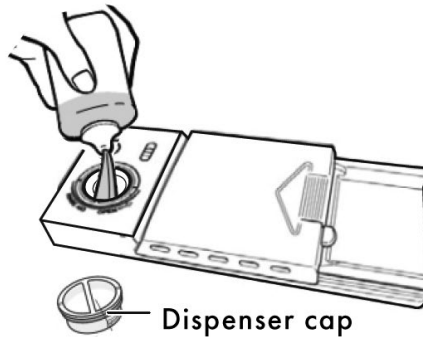

3. Replace the cap and turn it 1/4 turn clockwise.

OPERATION

USING RINSE AID

Rinse aid greatly improves drying and reduces water spots and filming. Without rinse aid, your dishes and dishwasher interior will have excessive moisture. In addition, the heated dry option will not perform as well without rinse aid. The rinse aid dispenser, located next to the detergent cup, automatically releases a measured amount of rinse aid during the last rinse. If spotting and poor drying is a problem, increase the amount of rinse aid dispensed by rotating the dial to a higher number. The dial is located under the dispenser cap.

If the rinse aid is low, the rinse aid light turns on at the beginning and end of the cycle indicating that it is time to refill. Refer to “Filling the Rinse Aid Dispenser” on page 18.

WATER TEMPERATURE

Hot water is required for optimum dishwashing and drying results. Water entering the dishwasher should be at least 120° F to achieve satisfactory results.

To check water temperature entering dishwasher:

1. Turn on the hot water faucet near the dishwasher and let it run for several minutes.
2. Hold a thermometer (a candy or meat thermometer will work) in the water stream to check the temperature. If temperature is below 120° F, have a qualified person raise the hot water heater thermostat setting.

Important:

To make sure that the water entering the dishwasher is hot, run hot water from the nearest hot water faucet to clear cool water from the pipe before starting the cycle.

HEAT DRY FUNCTION

The heat dry function, when used with a rinse aid, enhances drying performance. If you do not choose the heat dry function, items in your load that will not be completely dry at the end of the cycle.

WATER PRESSURE

For optimum performance, the hot water supply line for your dishwasher must provide water pressure of at least 20 psi and not more than 120 psi. You may experience low water pressure during high-demand periods, such as when laundry or showers are in use while you are washing the dishes. To eliminate this problem, wait until hot water demand is reduced before starting the dishwasher.

MAINTENANCE AND CLEANING

FACTORS AFFECTING PERFORMANCE

Caution:

TO AVOID BURN INJURY: Allow the heating element to cool before attempting to clean the interior of your dishwasher.

CLEANING THE STAINLESS STEEL PANEL

Clean the stainless steel door and handle regularly with a soft cloth and standard household cleaner to remove the debris.

Caution:

Do not use appliance wax, polish, bleach or products containing chlorine to clean the stainless steel door.

CLEANING THE CONTROL PANEL

Clean the control panel gently with a soft, lightly dampened cloth.

CLEANING THE STAINLESS STEEL INNER DOOR AND TUB

The tub is made of stainless steel. It will not rust or corrode, even if the dishwasher should be scratched or dented. Clean the spots on the steel inner door and tub with a damp non-abrasive cloth.

CLEANING THE FILTERS

The filters are designed to collect debris and need to be cleaned monthly to maximize wash performance.

1. Remove the bottom rack.



MAINTENANCE AND CLEANING

2. Rotate the cylinder filter, then lift it out.

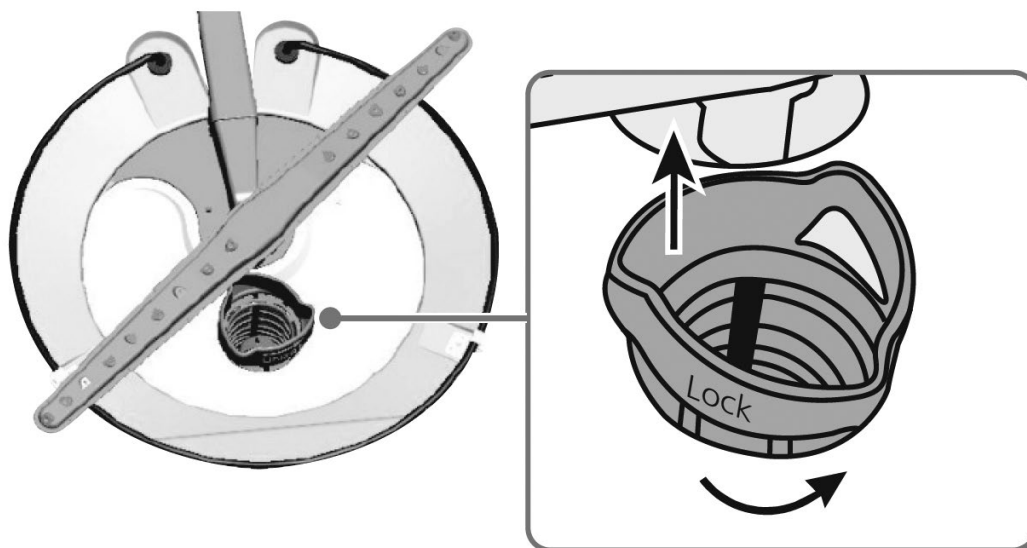

3. Lift the fine filter from the bottom of the tub.



4. Take out the fabric filter.

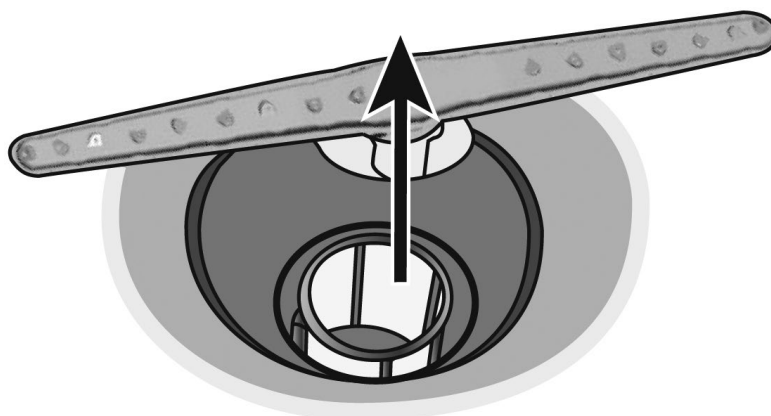

MAINTENANCE AND CLEANING

5. Flush the filters by holding them under running water.

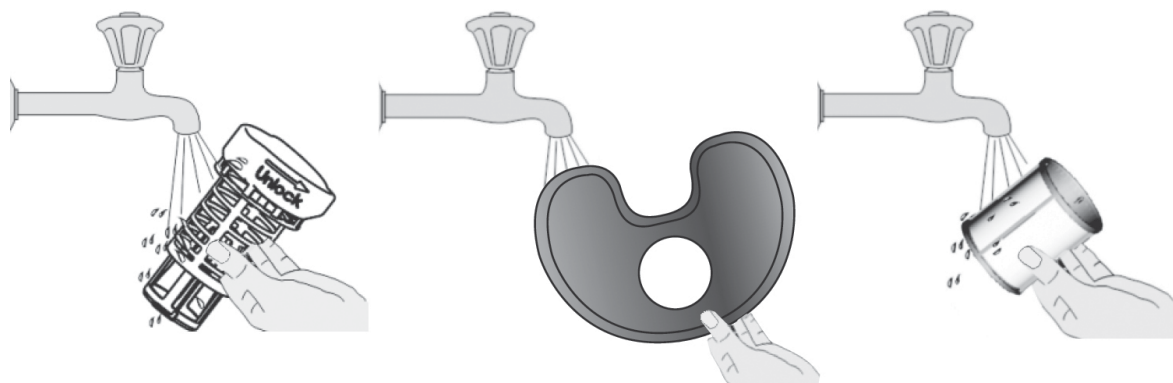

6. Replace the fabric filter.
7. Replace the fine filter.
8. Replace the cylinder filter.
9. Replace the bottom rack.

CLEANING THE DOOR AND TUB GASKETS

Clean the door gasket with a damp cloth to remove food particles regularly.



MAINTENANCE AND CLEANING

The inside of the dishwasher is self-cleaning under normal use. If needed, the tub gasket can be cleaned with a damp cloth. Use a brush to clean the opening in the end of the gasket.



CLEANING THE AIR GAP

If there is an air gap installed with your dishwasher, make sure it is clean so the dishwasher will drain properly. Air gap is not part of your dishwasher. Before you clean the air gap, turn off the dishwasher, then remove the plastic air gap cover and clean with a toothpick.

MAINTENANCE AND CLEANING

Your dishwasher should be protected from freezing if you plan to leave it for extended periods in an unheated place. Have a qualified person do the following:

To disconnect service:

1. Turn off the electrical power to the dishwasher at the supply source by moving fuses or tripping circuit breaker.
2. Turn off the water supply.
3. Place a pan under the inlet valve, then disconnect water line from the inlet valve and drain it into a pan.
4. Disconnect drain line from pump and drain the water into a pan.

To restore service:

1. Reconnect the water, drain, and electrical power.
2. Turn on water and electrical power supply.
3. Fill the detergent cup and the rinse aid cup and run the dishwasher through a heated-wash cycle.
4. Check all connections to make sure they do not leak.

TROUBLESHOOTING

Refer to this table to correct minor issues before calling for service.

ERROR CODES

If there is an air gap installed with your dishwasher, make sure it is clean so the dishwasher will drain properly. Air gap is not part of your dishwasher. Before you clean the air gap, turn off the dishwasher, then remove the plastic air gap cover and clean with a toothpick.

CODE	MEANING	POSSIBLE CAUSE
E1	Slow fill time/fill time has exceeded time allotted	<ul style="list-style-type: none">• Faucet is not opened• Water intake is restricted• Water pressure is too low
E4	Overflow	A leak in the dishwasher
E8	The orientation of the distributary valve not working.	The wire is not connected correctly, or the distributary valve is broken.
E9	A button has been touched for more than 30 seconds (by anything, including water).	Anything (including water) touching a button.

Caution:

- If an overflow occurs, turn off the main water supply before calling for service.
- If there is water in the base pan because of an overflow or small leak, the water should be removed before restarting the dishwasher.

TROUBLESHOOTING

PROBLEM	POSSIBLE CAUSE	POSSIBLE SOLUTION
The dishwasher won't start	The door may not be closed properly.	Make sure that the door is closed and latched.
	The power is off or not connected.	Make sure that the power is connected and turned on.
	The delay start option is selected.	Refer to the "Delay" section under "Controls and indicators" on page 9.
The dishwasher beeps at the end of the cycle	This is normal and indicates that the wash cycle is complete.	
The rinse aid light is on	The rinse aid level is low.	Add rinse aid.
The dishwasher runs too long	The dishwasher is connected to a cold water supply.	Make sure that the dishwasher is connected to a hot water supply. If not, change the water supply to a hot water source.
	The cycle time varies, depending on the soil level of the dishes.	When heavy soil is detected, the wash times will be longer.
	Depends on the option selected.	Some options will add time to the cycle.
The dishes are not drying enough	The rinse aid dispenser is empty or the setting is too low.	Fill the rinse aid dispenser. Increase the rinse aid setting.
	Dishes are loaded improperly.	Reload the dishwasher as shown in "Preparing and Loading Dishes" on page 11.
	The cycle you chose did not include drying.	Choose a cycle with drying.

TROUBLESHOOTING

PROBLEM	POSSIBLE CAUSE	POSSIBLE SOLUTION
The dishes are not clean enough	The water pressure is too low.	Make sure that the water pressure is above 20 psi. Use your dishwasher when water demand is low.
	The inlet water temperature is too low.	Make sure that the dishwasher is connected to a hot water supply. If not, change the water supply to a hot water source. Use your dishwasher when hot water demand is low.
	Dishes are too close together.	Reload the dishwasher as shown in "Preparing and Loading Dishes" on page 11.
	Improper use of detergent.	Add detergent depending on the water hardness and washing cycle you choose. Use fresh detergent.
	The selected cycle is not suitable for the soil level on the dishes.	Choose a different cycle with a longer washing time.
	The spray arms are blocked.	Make sure that the spray arms are not blocked and are free to rotate.
Spots and filming on dishes	Water hardness is too high.	For extremely hard water, install a water softener.
	Dishes are loaded improperly.	Reload the dishwasher as shown in "Preparing and Loading Dishes" on page 11.
	Old or damp rinse aid power is used.	Use fresh, liquid rinse aid.
	The rinse aid dispenser is empty or the setting is too low.	Fill the rinse aid dispenser. Increase the rinse aid setting.
Etching	Using too much detergent.	Use less detergent if you have soft water.
	The inlet water temperature exceeds 150° F.	Lower the inlet water temperature.

TROUBLESHOOTING

PROBLEM	POSSIBLE CAUSE	POSSIBLE SOLUTION
Detergent left in dispenser cup	Detergent may be too old.	Use fresh detergent.
	The spray arm is blocked.	When you load the dishes, make sure that the spray arms are not blocked.
The detergent dispenser will not close	Improper operation of the detergent cover.	Add detergent and rinse aid only as indicated in this manual. See "Filling the Detergent Dispenser" on page 17 and "Filling the Rinse Aid Dispenser" on page 18.
Water remains in the dishwasher.	The previous cycle has not finished or has been interrupted.	Make sure that the current cycle is finished.
The dishwasher does not drain properly.	The drain is clogged.	Check the air gap (if so equipped). Make sure that the disposer is empty (if so connected).
	The drain hose is kinked.	Make sure that the drain hose is not kinked and is properly connected.
Suds in the tub	Using improper detergent, or pod style cleaners.	Make sure to use only automatic dishwasher detergent.
		The dispenser is not designed for the use of pods. To use pods, throw them into the bottom of the tub and it will release the detergent like normal.
The dishwasher leaks	Excessive suds caused by using improper detergent.	Make sure to use only automatic dishwasher detergent.
	The dishwasher is not level.	Level the dishwasher (refer to the Installation Manual).

TROUBLESHOOTING

PROBLEM	POSSIBLE CAUSE	POSSIBLE SOLUTION
There are black or gray marks on the dishes	Aluminum utensils have rubbed against the dishes.	Make sure that the water inlet temperature is not less than 120° F.
The interior of the tub is stained	Coffee or tea stains.	Use a spot cleaner to remove the stains.
	Reddish stain.	Some tomato products may cause this. Use of the rinse only cycle right after loading will help this.
Noises	Detergent cup opening/drain pump.	This is normal.
	A hard object has entered the wash module. When the object is ground up the noise will stop.	If the noise continues after the cycle is complete, call for service.
The dishwasher won't fill (the dishwasher will beep)	The water valve is turned off.	Turn on the water valve.
	The door may not be closed completely.	Make sure that the door is closed and latched.

WARRANTY

COVERAGE

ZLINE Kitchen and Bath dishwasher products will be warrantied for one year from the original purchase date for the original purchaser of the product. This warranty covers all parts and labor for necessary repairs if any part of the product proves to be defective in materials or workmanship. The product must be deemed serviceable via troubleshooting with the ZLINE Kitchen and Bath service team. All service on ZLINE Kitchen and Bath dishwasher products under the above warranty must be performed by ZLINE approved and certified service, unless otherwise specified by ZLINE Kitchen and Bath. Service will be provided during normal business hours.

TERMS

This warranty applies only to the original purchaser of the product installed for normal residential use. This is defined as a single-family, residential dwelling in a non-commercial setting. Commercial settings include but are not limited to: schools, churches, hotels, restaurants, vacation rentals such as Airbnb, day care centers, private clubs, fire stations, common areas in multi-family dwellings, nursing homes, food service locations, and institutional food service locations such as hospitals or correction facilities. This warranty is non-transferable and will not be extended based on the date of installation. The warranty applies only to products installed in the continental United States and the District of Columbia.

Failure to secure certified warranty service per these terms will result in a forfeiture of the remaining warranty. Out of pocket payments will not be reimbursed unless prior approval is received from ZLINE Kitchen and Bath and/or our service contract partner. Unapproved out of pocket payments for service will not be reimbursed. All warranty procedures must be followed to maintain warranty coverage.

Warranty shall not apply and ZLINE Kitchen and Bath is not responsible for damage resulting from negligence, improper maintenance, misuse, abuse, alteration of or tampering with the appliance, accident, natural disaster, improper electric supply, unauthorized service or repair, improper installation, or installation not in accordance with the instructions contained in the manual or the local government codes.



WARRANTY

WHAT IS NOT COVERED

1. Installation or start-up damages or problems caused by improper installation or use.
2. Damage related to unauthorized service or unauthorized parts.
3. Installation in any commercial or non-residential application.
4. Aesthetic damage, scratches, or natural wear caused by normal use.
5. Second-hand, open box products, or products purchased from an unauthorized retailer.

NOTE: In the event that service is dispatched, and it is discovered that the reported issue is not covered under warranty based on the disclaimers above, the customer will be responsible for all service fees. Failure to pay these fees will result in the forfeiture of remaining warranty coverage.



	DISHWASHER MODEL-DWMT-24				
	SN.:		Energy Verified Refrigerant Energétiquement Vérifié Made in China		
VOLTAGE	120V AC	FREQUENCY	60Hz	PHASE	Single
TOTAL AMPS	8.4A	MOTOR	1.0A	HEATER	7.4A

The rating tag shows the model and serial number of your dishwasher. The product label and rating tag is located on the right-hand side of the inner door of the dishwasher. The tag is visible when the dishwasher door is open. Do not remove permanently affixed labels, warnings, or plates from the product. This will void the warranty.



SERVICE

For warranty service, please contact our Customer Service team at 1-614-777-5004 or visit www.zlinekitchen.com/contact to utilize our online Customer Experience Portal.



Need to purchase a part or accessory for your ZLINE product? Visit ZLINEparts.com, ZLINE's official parts distribution partner.

2.1.0

www.zlinekitchen.com

1-614-777-5004

contact@zlinekitchen.com

ZLINE
ATTAINABLE LUXURY®