

**FLUSH PULL FOR 8" DOOR PULL**

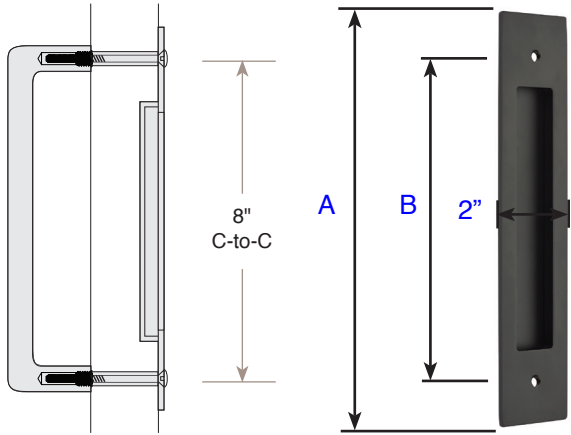

Drilled to accept 8" pull

Thickness:  $\frac{3}{8}$ "  
A= 10"  
B= 8" Screw-to-Screw

Modern Rectangular  
Flush Pull  
for Door Pull  
(221710)  
*Flush Pull Only*

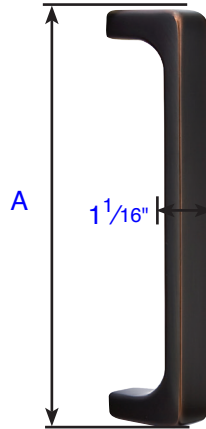

Baden Pull (86184)  
Stainless Steel  
Baden Pull  
(S86002)

Projection: 2  $\frac{1}{8}$ "  
A= 8  $\frac{5}{8}$ "  
Base: 1" x  $\frac{1}{16}$ "

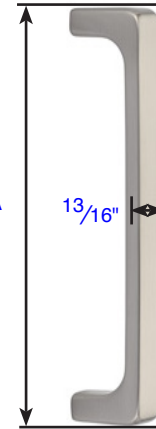

Brisbane  
Pull (86170)  
Projection: 1  $\frac{13}{16}$ "  
A= 8  $\frac{9}{16}$ "  
Base:  $\frac{13}{16}$ " x  $\frac{9}{16}$ "

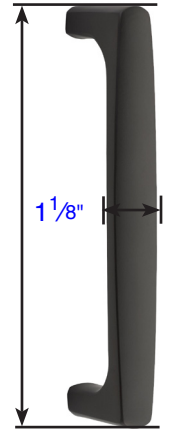

Urban Modern  
Pull (86176)  
Projection: 1  $\frac{7}{8}$ "  
A= 8  $\frac{5}{8}$ "  
Base:  $\frac{7}{8}$ " x  $\frac{3}{4}$ "

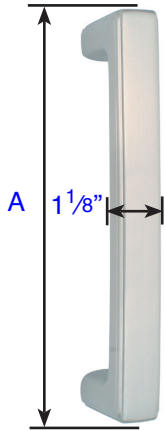

Wilshire Pull (86078)  
Projection: 2  $\frac{1}{8}$ "  
A= 8  $\frac{7}{8}$ "  
Base: 1  $\frac{1}{8}$ " Diameter

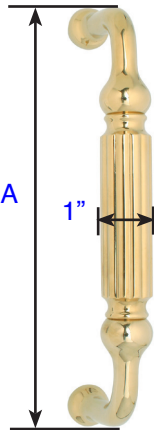

Knoxville Pull (86077)  
Projection: 2  $\frac{1}{2}$ "  
A= 8  $\frac{13}{16}$ "  
Base:  $\frac{3}{4}$ " Diameter

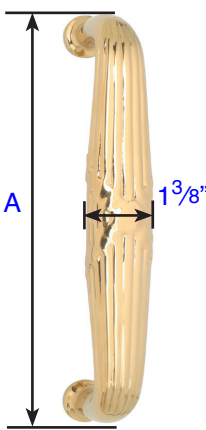

Ribbon & Reed Pull  
(86080)  
Projection: 2  $\frac{3}{8}$ "  
A= 8  $\frac{15}{16}$ "  
Base: 1" Diameter

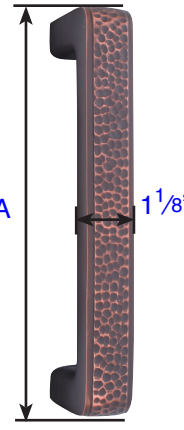

Arts & Crafts Pull  
(86079)  
Projection: 2  $\frac{1}{8}$ "  
A= 8  $\frac{7}{8}$ "  
Base: 1  $\frac{1}{8}$ " Diameter

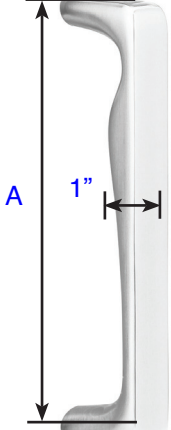

Zeus Pull (86183)  
Stainless Steel  
Zeus Pull  
(S86001)  
Projection: 2  $\frac{1}{8}$ "  
A= 8  $\frac{5}{8}$ "  
Base: 1" x  $\frac{1}{16}$ "

**Discontinued.  
No Longer Available**

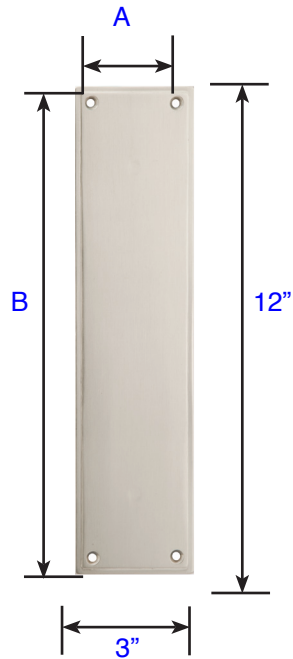

Modern Push Plate  
(86436)

A= 2<sup>1</sup>/<sub>8</sub>" Screw-to-Screw  
B= 11<sup>1</sup>/<sub>8</sub>" Screw-to-Screw

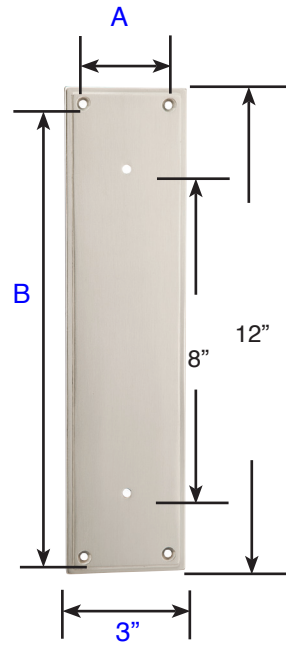

Modern Pull Plate (86437)  
Plate only  
Drilled to accept 8" pull

A= 2<sup>1</sup>/<sub>8</sub>" Screw-to-Screw  
B= 11<sup>1</sup>/<sub>8</sub>" Screw-to-Screw

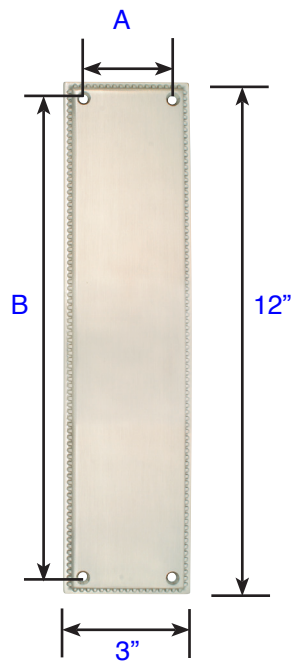

Knoxville Push (86081)  
Plate

A= 2<sup>1</sup>/<sub>8</sub>" Screw-to-Screw  
B= 11<sup>1</sup>/<sub>8</sub>" Screw-to-Screw

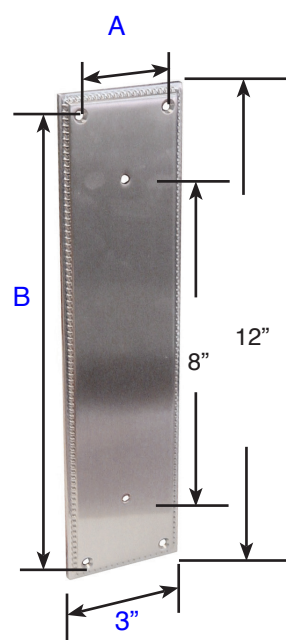

Knoxville Pull Plate (86082)  
Plate only  
Drilled to accept 8" pull

A= 2<sup>1</sup>/<sub>8</sub>" Screw-to-Screw  
B= 11<sup>1</sup>/<sub>8</sub>" Screw-to-Screw

8 3/4" Screw-to-Screw

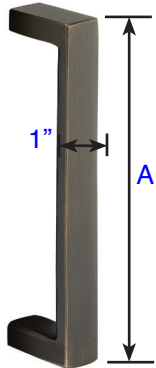

8 3/4"  
Bronze Rustic  
Modern Rectangular  
(86180)

A = 9 1/2"  
Projection: 2"  
Base: 1" x 1 1/16"

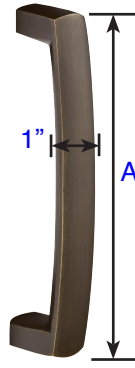

8"  
Bronze Rustic  
Modern Arched  
(86439)

A = 8 1/2"  
Projection: 2 1/2"  
Base: 1 3/16"

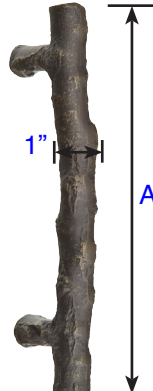

8"  
Bronze Twig Pull  
(86090)

A = 11"  
Projection: 3"  
Base Diameter: 7/8"

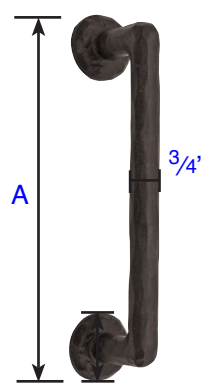

8"  
Bronze Rod Pull  
(86088)

A = 9 13/16"  
Projection: 2 9/16"  
Base Diameter: 1 13/16"

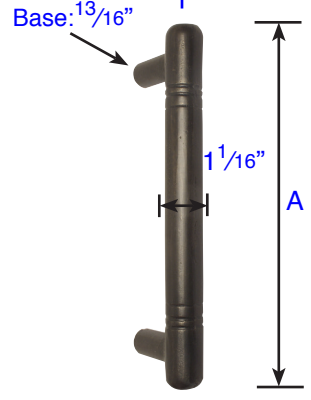

8"  
Bronze Nunez Pull  
(86160)

A = 9 7/8"  
Projection: 2 3/4"  
Clearance: 1 11/16"

Standard Components:

- 1", 10-32 Screws
- 1", 1/4"-20 Screws
- Inserts for 1/4"-20 screws
- Inserts for 10-32 screws

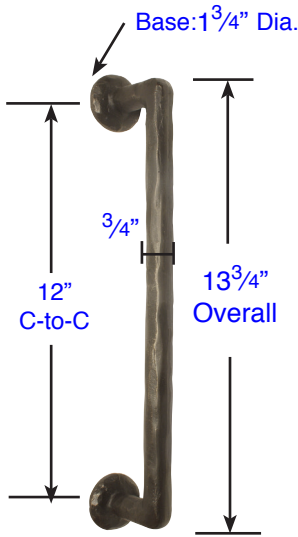

12"  
Bronze Rod Pull  
(86068)

Projection: 2 9/16"  
Clearance: 1 3/4"

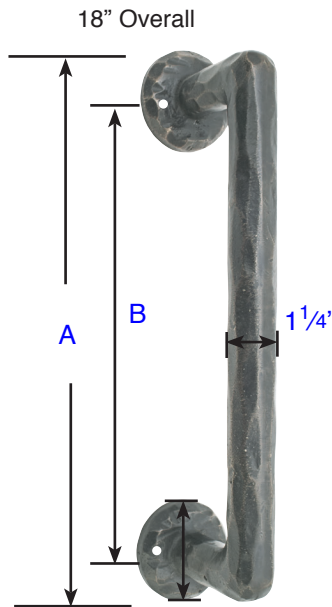

18"  
Bronze Rod Pull  
(86089)

A = 18" B = 15"  
Projection: 3 3/16"  
Base Diameter: 3"

Screw Specifications  
Bronze 18" Pulls

- Standard Components:
- #10, 1" Wood Screws

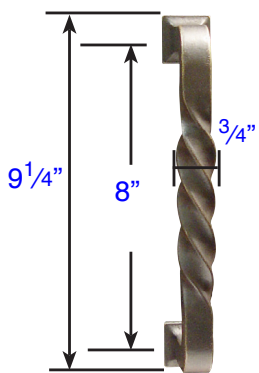

Tuscany 8" Twist Pull  
(86069)

Projection:  $2\frac{3}{4}$ "  
Base =  $1\frac{1}{4}$ "  
Squared

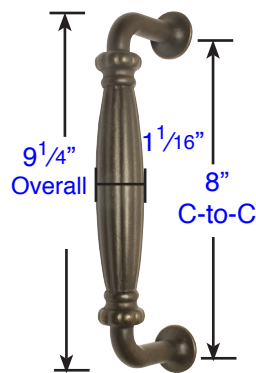

Tuscany 8" Palermo Pull  
(86167)

Projection:  $2\frac{13}{16}$ "  
Clearance:  $1\frac{3}{4}$ "  
Base:  $1\frac{1}{4}$ " Dia.

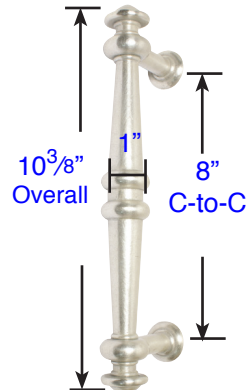

Tuscany 8" Recoleta Pull  
(86168)

Projection:  $2\frac{7}{8}$ "  
Clearance:  $1\frac{5}{8}$ "  
Base:  $1\frac{3}{16}$ "

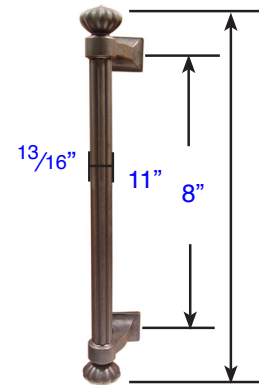

Tuscany 8" Column Pull  
(86156)

Projection: 3"  
Base =  $1\frac{1}{4}$ "  
Squared

**Screw Specifications  
Tuscany Bronze 8" Pulls**

- Standard Components:
- 1", 10-32 Screws
  - 1", 1/4"-20 Screws

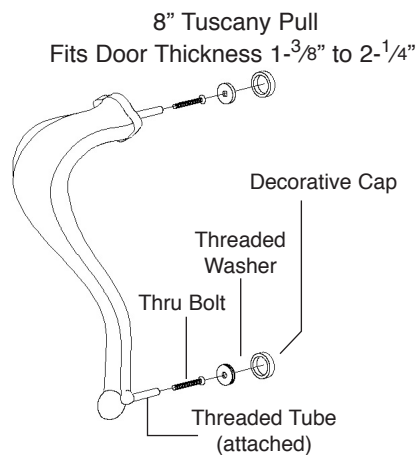

Screw Specifications  
Art Nouveau 8" Pull  
•  $1\frac{1}{2}$ ", 8-32 Screws

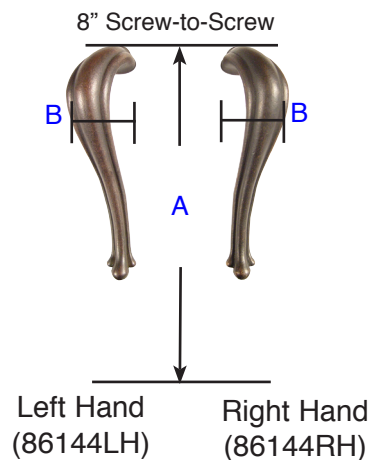

A =  $9\frac{3}{16}$ " B =  $1\frac{7}{16}$ "  
Projection:  $2\frac{1}{2}$ "

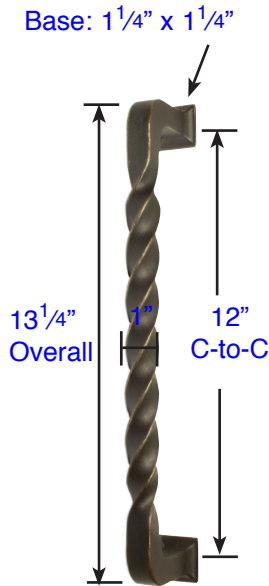

Tuscany 12" Twist Pull (86169)

Projection: 2<sup>3</sup>/<sub>4</sub>"  
Clearance: 1<sup>13</sup>/<sub>16</sub>"

**Discontinued.  
No Longer Available**

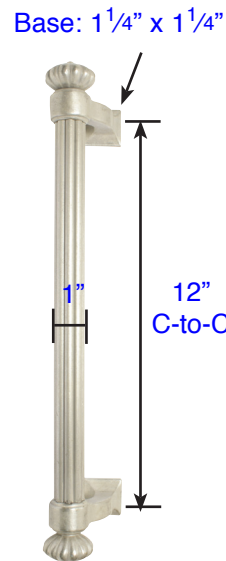

Tuscany 12" Twist Pull (86159)

Projection: 3"  
Clearance: 2"

**Discontinued.  
No Longer Available**

Standard Components:

- 1", 10-32 Screws
- 1", 1/4"-20 Screws
- Inserts for 1/4"-20 screws
- Inserts for 10-32 screws

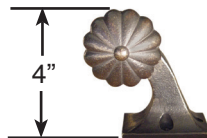

Tuscany 18" Column Pull (86157)  
Supplied with #10 wood screws.

A = 13<sup>7</sup>/<sub>16</sub>" Screw-to-Screw  
Base = 2"L, 2<sup>3</sup>/<sub>4</sub>"W

**Discontinued.  
No Longer Available**

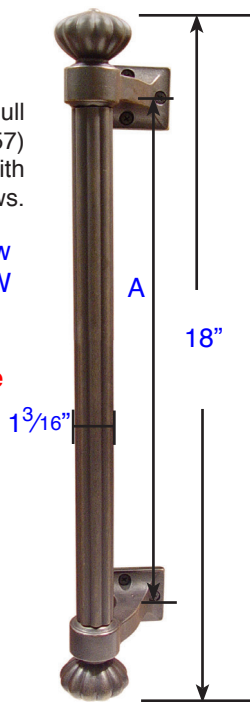

Tuscany 24" Column Pull (86158)  
Supplied with #10 wood screws.

A = 19<sup>7</sup>/<sub>16</sub>" Screw-to-Screw  
Base = 2"L, 2<sup>3</sup>/<sub>4</sub>"W

**Discontinued.  
No Longer Available**

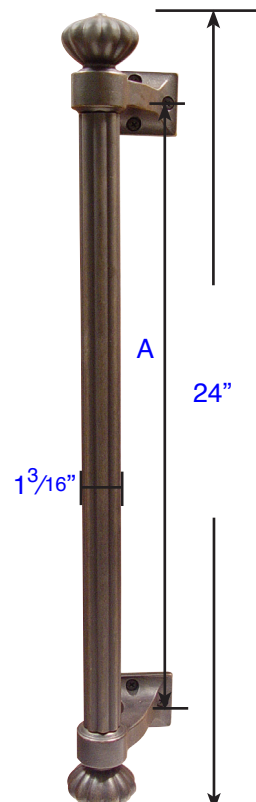

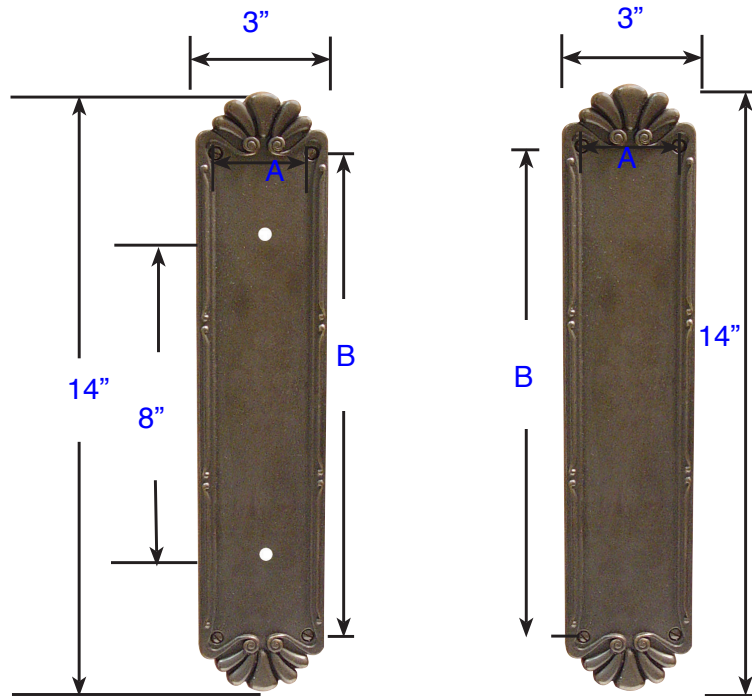

Tuscany Petal  
Pull Plate (86182)  
Plate only  
drilled to accept 8" pull

Tuscany Petal  
Push Plate (86181)

A = 2<sup>5</sup>/<sub>32</sub>" Screw-to-Screw  
B = 11<sup>1</sup>/<sub>4</sub>" Screw-to-Screw

A = 2<sup>5</sup>/<sub>32</sub>" Screw-to-Screw  
B = 11<sup>1</sup>/<sub>4</sub>" Screw-to-Screw

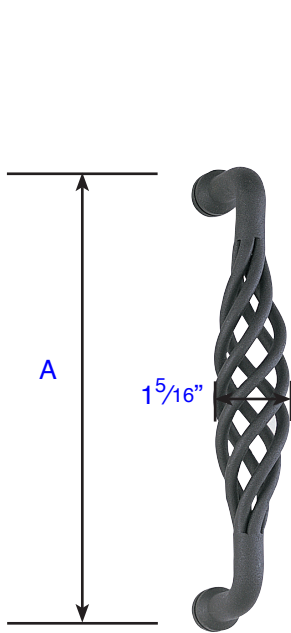

Lafayette (76030)

A =  $8\frac{13}{16}$ "  
Projection:  $2\frac{1}{2}$ "  
Base:  $\frac{3}{4}$ " Diameter

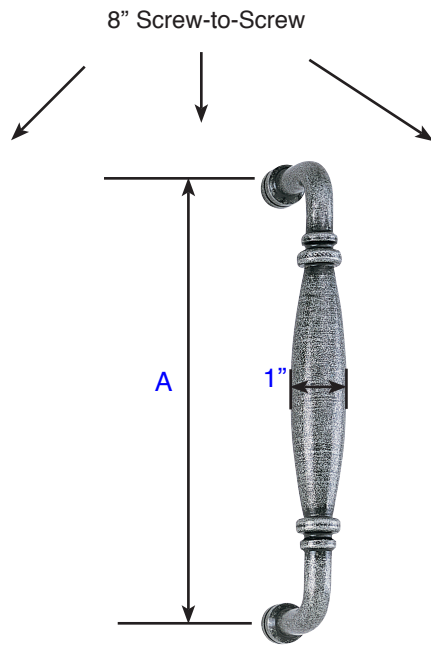

Normandy (76031)

A =  $8\frac{13}{16}$ "  
Projection:  $2\frac{1}{2}$ "  
Base:  $\frac{3}{4}$ " Diameter

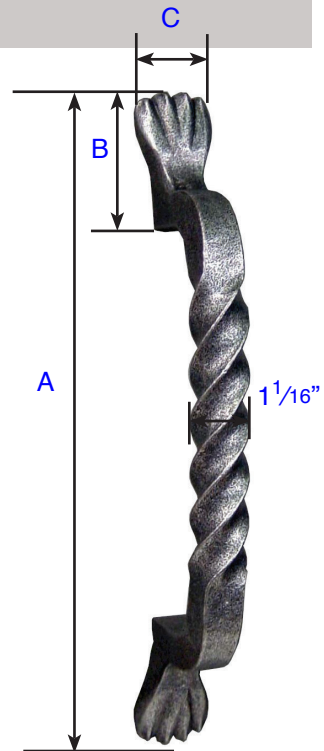

San Carlos 8" (76028)

A =  $12\frac{1}{4}$ ", B =  $2\frac{1}{2}$ ", C =  $1\frac{1}{8}$ "  
Projection:  $2\frac{7}{16}$ "

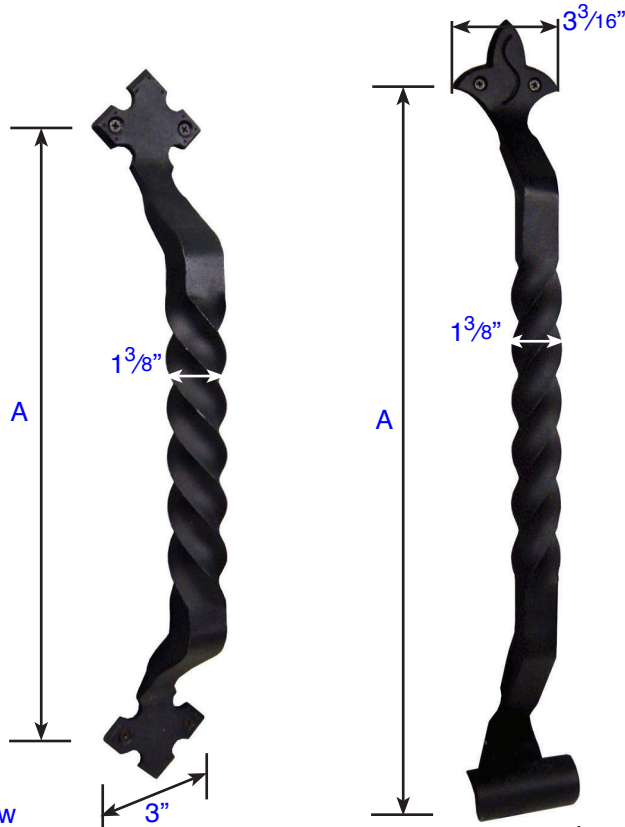

A =  $14\frac{3}{4}$ " Screw-to-Screw  
Projection: 3"

San Carlos, 18" (76029)

A =  $21\frac{15}{16}$ " Screw-to-Screw  
Projection: 3"

San Carlos, 24" (76041)

**Screw Specifications  
Wrought Steel 8" Pulls**

Standard Components:

- 1", 10-32 Screws
- 1",  $\frac{1}{4}$ "-20 Screws
- Inserts for  $\frac{1}{4}$ "-20 screws
- Inserts for 10-32 screws

**Screw Specifications  
Wrought Steel 18" & 24" Pulls**

Standard Components:

- #10, 1" Wood Screws